



Parts & Accessories



Heating System and Outdoor Furnace Products

WoodMaster.com

Table of Contents

HEATING SYSTEM PRODUCTS

Heat Exchangers - Water-to-Air	1-4
Heat Exchangers - Water-to-Water	5-7
Heat Exchangers - Convection	8
Piping - ThermoPEX	9
Piping - EZ Lay and 1-1/4" PEX Crimp Fittings	10
Piping - Fittings	12
Circulators	13
Circulators & Cartridges	14
Circulators & Related	15
Manifolds	16
HeatLink Products	17-19
Fittings and Tools - PEX	20-21
Fittings - Threaded	22-24
Fittings - Sharkbite	25
Fittings - Copper/Sweat	27-28
Aquastats / Thermostats	29
Valves	30-31

OUTDOOR FURNACE PRODUCTS

Chimney	32-33
Antifreeze, Corrosion Inhibitor, Treatment	34
Furnace Replacement Parts	35-37
AFS Replacement Parts	38
Flex Fuel Replacement Parts	39-40
Renovator Replacement Parts	41
Options and Tools	42
CleanFire Furnace Parts & Accessories	43-48
Maxim Furnace Parts & Accessories	49-52

Alphabetical Index

24V Fan Conversion Kit	42	Chimney Guy-Wire Band Kit, 8"	45
3-Way Zone Valve, Sweat	30	Chimney Lengths - Maxim	50
Actuator Motor, Fuel Door	51	Chimney Rope Ring	46
Actuator, Thermal.	16	Chimney Sections, 6" - CleanFire 300 and 500.	45
Adapter, Brass	22	Chimney Sections, 6" - Maxim	50
Adapter, Female 1" NPT - for Manifold Kits	16	Chimney Sections, 8" - CleanFire 700	44
Adapter, Female, 3/4" Hose, Brass	23	Chimney Tee Covers	46
Adapter, Female - Copper Pipe	20	Chimney Tee Kits, Stainless Steel	45
Adapter, Male, 3/4" Hose, Brass	23	Cinch Tool	21
Adapter, PEX 90° Elbow - Threaded Pipe	20	Clamp Crimp Ring, PEX Stainless Steel	21
Adapter, PEX - Threaded Pipe	20	Clamp Crimp Ring Removal Tool	21
Adapters, Female - Copper	28	Clamp, Snaplock Chimney - 8".	32
Adapters, Male - Copper	27	Cleaner	34
Adapters, PEX 90° Elbow	20	CleanFire Kit for Delivery Trailer	42
Adapters, PEX - Copper Pipe	20	Cleaning Rod - CleanFire	48
Adapters, PEX - Threaded Pipe	20	Cleaning Rod - Maxim	49
Aerator	52	Cleaning Tool, Afterburner	48
AFS Replacement Parts	38	Cleaning Tool, Heat Exchanger	48
AFS Replacement Parts - Augers	38	Combustion Air Tube	46
AFS Replacement Parts - Fire Pot	38	Combustion Fan Assembly.	43
AFS Replacement Parts - Motor Items	38	Combustion Fan Kit	51
Air Channel, Front, Kit - CleanFire 300	47	Connectors, Lever Nut.	51
Air Channel, Front, Kit - CleanFire 500	47	Controller, FireStar - CleanFire	44
Air Channel, Front, Kit - CleanFire 700	47	Controller, FireStar II - Maxim	51
Air Charge Tube.	46	Cord, Power Supply	15
Air Handler Cabinet	2	Corn Aerator Kit - Maxim	50
Air Handlers	1	Corn Aerator Paddle Kit - Maxim	50
Aluminum Heat Transfer Plate.	19	Coupler, Brass	22
Antifreeze	34	Coupling, 25mm PEX	12
Aquastats & Thermostats	29	Couplings, 1/2" and 1" PEX.	12
Ash Removal Systems	37	Couplings, Copper	27
Ash Scoop - Maxim.	49	Crimp Tool, Universal	21
Auger Chains	37	Dixell Temp Control	35
Auger Flighting/Shaft	49	Door Cover Insulation, Rear	48
Auxiliary Auger Kits - Maxim	49	Door Insulation, Inside Rear Cleanout	48
Auxiliary Auger Vibrator w/Timer Kit - Maxim	50	Door Insulation, Rear Cleanout	47
Bag Holder Kit - Maxim	50	Door Rope and Seals - CleanFire	47
Ball Valve	31	Door Seal	44
Ball Valve, PEX	31	Draft Inducer Kits.	33
Ball Valve, Sweat	31	Elbow, 45° Street	23
Blower & Motor	2	Elbow, 90° - Copper	27
Blue PureLink® Plus UV Stabilized PEX-a Tubing.	17	Elbow, 90° - FPT	24
Brush, Cleaning	28	Elbow, 90° Reducing - Copper	27
Brush, Stainless Steel	42	Elbow, 90° Street	24
Burn Chamber Gasket Only - M255 PE.	52	Elbow, 90° Street - Copper	27
Burn Chamber w/Gasket - M255 PE	52	Elbow, Brass	22
Burner Auger - M255 PE.	52	Elbow, Primary Air Inlet, Rubber	47
Bushing/Collar - Door Latch	44	Elbow, Secondary Air Inlet, Rubber.	47
Bushing, Hex - NPT.	23	Elbow, Vent - Copper	27
Cap, Copper End	27	ETC Assembly, Wood Stove.	35
Cap - for Manifold Kits	16	E-Z Lay Insulated Pipe	10
Caps, Round Pipe	24	Fan Center Relay	29
Central PEX 1/2" Pipe	17	Fan Coil Unit, 50k Btu	1
Central PEX 1" Pipe.	12	Fan Coil Unit, 100k Btu	1
Central PEX 1" Pipe Sections.	12	Fan Coil Unit, 220k Btu	2
Check Valves.	30	Filter & Fill Valve Kits	7
Check Valve, Swing - Brass	30	Firebox Door.	35
Chimney Attachment Ring	45	Fittings, 1-1/4" PEX (CTS)	10
Chimney Band Clamp Kit, 6"	45	Fittings, Brass - for 1-1/4" PEX Pipe (SDR-11)	12
Chimney Band Clamp Kit, 8"	32	Fittings Kit, Push-fit - for Water-to-Water Heat Exchanger	6
Chimney Band Clamp Kit, 8"	45	Fittings Kit, Water Heater - for Water-to-Water Heat Exchanger	6
Chimney Base Brace Kit, 8"	32	Fittings , PEX	12
Chimney Box Assembly	50	Flange, 3/4" Isolation - with Drain Valve.	15
Chimney Box Cover Assembly.	50	Flange Kit, Isolation	15
Chimney Cap/Spark Arrestor	32	Flanges, Pump.	15
Chimney Cap/Spark Arrestor	45	Flex Fuel Replacement - Draft Fan and Capacitor	40
Chimney Guy-Wire Band, 6"	45	Flex Fuel Replacement Parts - Ash Tools	40
Chimney Guy-Wire Band Kit, 8"	32	Flex Fuel Replacement Parts - Buffer Temperature Probe	40

Alphabetical Index

Flex Fuel Replacement Parts - Control Panel Displays	40	PEX Connectors for TwistSeal Manifolds	18
Flex Fuel Replacement Parts - Display Knob	40	PEX Fittings - 1" PEX	20
Flex Fuel Replacement Parts - Display Mounting Hardware	40	PEX Hanger	21
Flex Fuel Replacement Parts - Door Hinge	39	PEX Pipe Cutter	21
Flex Fuel Replacement Parts - Door Rope	39	Plate Exchangers	5
Flex Fuel Replacement Parts - Firebox Door Latch	39	Plug, Pipe - MPT	24
Flex Fuel Replacement Parts - Funnels	39	Plug, Pipe - Wrench Set	24
Flex Fuel Replacement Parts - Grates	39	Power Supply	44
Flex Fuel Replacement Parts - Handles	39	Pump Cartridges	14
Flex Fuel Replacement Parts - Heat Exchanger Gaskets	39	Pump Panel Extension Kit - CleanFire 300/500	43
Flex Fuel Replacement Parts - Heat Exchanger Motor	39	Pump, Taco - 007 Series	13
Flex Fuel Replacement Parts - Heat Exchanger Motor Bearing	39	Pump, Taco - 009 Series	13
Flex Fuel Replacement Parts - I/O Board	40	Pump, Taco - 0011 Series	13
Flex Fuel Replacement Parts - Leveling Foot	40	Pump, Taco - 014 Series	13
Flex Fuel Replacement Parts - Primary Air Plates	39	Pump, Taco - 0015e3™	14
Flex Fuel Replacement Parts - Servomotor	40	Pump, Taco - 2400-20	13
Flex Fuel Replacement Parts - Snap Disc	40	Pump, Taco - Viridian® VR1816	14
Flex Fuel Replacement Parts - Solenoid	40	Pump, Taco - Viridian® VT2218	14
Flue Brush & Handle	49	Push-fit - Depth Gauge/Deburring Tool	26
Gauge, Temperature	24	Push-fit - Disconnect Clip	26
Gauge, Temperature - for Manifold Kits	16	Push-fit - Disconnect Tongs	26
Grounding Rod Kit	49	Push-fit Fitting - Adapter, Male	26
Hanging Units with Louvers (All Lines 1" Sweat)	1	Push-fit Fitting - Connector, Straight	26
Heat Exchanger Coil (50k Btu)	4	Push-fit Fitting - Coupling, Reducing	26
Heat Exchanger Coil (80k Btu)	4	Push-fit Fitting - Female Adapter	26
Heat Exchanger Coil (95k Btu)	4	Push-fit Fittings - Coupling, Straight	26
Heat Exchanger Coil (100k Btu)	4	Push-fit Fittings, Elbow	26
Heat Exchanger Coil (125k Btu)	4	Push-fit Fitting, Tee	26
Heat Exchanger Coil (140k Btu)	4	Push-fit Fitting - Temperature Gauge	26
Heat Exchanger Coil (185k Btu)	4	Radiant Baseboard Heaters, Complete	8
Heat Exchanger Coil (220k Btu)	4	Radiant Mixing Valve, Sweat	30
Heat Exchanger Coils	3	Ratchet Cinch Tool	21
Heat Exchanger, Plate	5	Reducer Bushing, Black	23
Heat Exchanger, Stainless 316L - for Swimming Pool	6	Reducer Bushing, Brass	22
Heat Exchanger, Titanium - for Swimming Pool	7	Reducer, Copper	27
HeatLink® Manifold Actuators with LED	18	Refractory, Fireball Tunnel	46
HeatLink® PEX-a Tubing with O2 Barrier	17	Refractory, Upper - CleanFire	46
HeatLink® Valve Actuator with LED	18	Relay, 24-Volt	29
Hoe, Ash	42	Renovator Replacement Electronics	41
Hoe, Firebox	42	Renovator Replacement Parts - Auger	41
Hopper, 48-Bushel Kit - Maxim	49	Renovator Replacement Parts - Burn Pot	41
Hopper Vibrator Kit - Maxim	50	Renovator Replacement Parts - Combustion Fan	41
Hose Bib, Brass	31	Renovator Replacement Parts - Compressor	41
Ignitor - M255 PE	51	Renovator Replacement Parts - Hopper Boot	41
Inspection Window Components	52	Renovator Replacement Parts - Shroud	41
Insulation, Firebox Door - Maxim	51	Replacement Door Rope	35
Kickspace Heaters	8	Replacement Fan	35
Latch, Pump Panel	48	Replacement Fan Cover	35
Lens and Light Bulb	43	Replacement Harnesses	36
Manifold Kit Connectors	16	Replacement Night Light Glass Cover	36
Manifold Kits	16	Replacement On/Off Switch	36
Mixing Valve, 1" x 4-way FNPT	18	Replacement Seal Kits and Gaskets	15
MolyArmor 350 Corrosion Inhibitor	34	Replacement Silicone	35
Moly/pH Test Kit	34	Replacement Temperature Probe	36
Motor, Burner Auger	51	Replacement Thermistor	36
Motor, Isolation Auger - Kit	51	Replacement Thermowell	36
Motor, Stepper - Assembly	43	Replacement Vent Cap	37
Mounting Bracket, Plate Heat Exchanger	5	Replacement Water Level Light	36
Mounting Brackets - Swimming Pool Heat Exchangers	7	Replacement Water Pressure Switch	36
Mounting Kit, Plate Heat Exchanger	5	Rope, Door Seal	44
Mounting Kit, Plate Heat Exchanger, 5x12, Universal	5	Rope, Door Seal and Chimney Transition Box Cover	50
Mount Kit, Wall - Taco Pump	15	Scraper Tool	48
Multimeter, Digital Pocket	42	Sediment Trapper Filter, Hot Water, 3/4"	42
Nipple, Black	23	Sensor Kit, Water Temperature - CleanFire	44
Nipple, Brass	22	Sensor Kit, Water Temperature - Maxim	52
Nipple, Close - Black	23	Sharkbite Ball Valve	25
Panel Radiators	8	Sharkbite Fitting - Adapter, Male	25
PEX 1-1/4" Pipe (SDR-11)	12	Sharkbite Fitting - Coupling, Reducing	25

Alphabetical Index

Sharkbite Fitting - Female Adapter	25	ThermoPEX Coupling Kit - 25mm.	9
Sharkbite Fittings	25	ThermoPEX Termination Cap	9
Sharkbite Fittings - Coupling, Straight	25	ThermoPEX with 1" or 1-1/4" PEX	9
Sharkbite Fittings, Elbow	25	ThermoPEX with 25mm PEX	9
Sharkbite Fitting, Tee	25	Thermostatic Head with 6' Remote Capillary	18
Shock, Hopper Lid	52	Thermostat, Line Voltage	29
Sight Gauge Components	48	Thermostat, Plug-in	29
Slide Rod/Assemblies	37	Tools - PEX	21
Slide Rod Plates	37	Torch, Outdoor	42
Sludge Conditioner	34	Transfer Auger - M255 PE	52
Snap Disc - CleanFire	43	Transformer, 24V	51
Snap Disc - Maxim	52	Transformer, 24-Volt	29
Solder & Soldering Flux	28	Turbulator, Rear Heat Exchanger	48
Straight Zone Valve	18	Twist-Lock Chimneys (Security)	33
SuperPro Chimneys - 6" Diameter	32	TwistSeal® Mini 2-Port Zone Valve Supply & Flow Meter Return Module Pair	19
SuperPro Chimneys - 8" Diameter	32	TwistSeal® Mini 3-Port Zone Valve Supply & Flow Meter Return Module Set.	19
SuperPro Chimneys (Selkirk)	32	TwistSeal® Mini (40 mm) Manifold Assembly Kit	19
Switch, Bypass Alarm	43	TwistSeal® Mini Deluxe Supply/Return Module	18
Switch, Door - CleanFire.	43	Union, Brass Pipe - FIP	22
Switch, Float - Water Level	44	Valve Bodies, Thermostatic Radiator	8
Switch, Float - Water Level	52	Valve Head, TRV II.	8
Switch, Paddle	51	Valve, Radiant Mixing	31
Switch, Rocker.	43	Valve, Tempering	31
Tee, Black	23	Valve, Water Heater Mixing.	31
Tee, Brass	22	Variable Speed Controls for Hanging Units.	1
Tee, Brass, 3/4".	22	Vent Cap	48
Tee, Brass Diverter	27	Vent Cap	52
Tee, Brass Offset, 4".	22	Vent Valve, Automatic	30
Tee, Brass - PEX	20	Water Heater Tube Kit	6
Tee, Reducing - Copper	28	Water-to-Water Heat Exchanger for Domestic Water Heater.	6
Tees, Copper	28	Wiring Harness, Main	52
Tees, NPT	23	Y-Strainer	7
Tempering Valve, Sweat.	30	Zone Valves, Zone Sentry®	30
Thermal Valve Replacement Components	49		
Thermocouple Kit, Universal	43		
ThermoPEX Coupling Kit - 1" and 1-1/4"	9		

Heat Exchangers - Water-to-Air

Air Handlers



0020-002

WoodMaster Air Handlers offer forced air comfort in the home and can be used in conjunction with any outdoor wood fired heating system. Sized for easy installation, the units are unidirectional and can be installed for upward, downward or horizontal air flow. Each unit includes the heat exchanger, fan, filter rack and filter.

Features:

- Galvanized Construction
- Direct Drive Blower
- Capacitor Start Motors
- Painted Exterior
- 3-Speed Fan
- Sealed Motor Bearings
- 24V Controls

- 0020-002 Air Handler, 100k Btu, 1"
- 0020-003 Air Handler, 125k Btu, 1"
- 0020-004 Air Handler, 140k Btu, 1"
- 0020-005 Air Handler, 160k Btu, 1"
- 0020-006 Air Handler, 200k Btu, 1"

Hanging Units with Louvers (All Lines 1" Sweat)

0020-030



- 0020-022 Fan Coil Unit, 100k Btu, with Louvers
- 0020-023 Fan Coil Unit, 140k Btu, with Louvers
- 0020-024 Fan Coil Unit, 200k Btu, with Louvers

Variable Speed Controls for Hanging Units

- 0020-030 Speed Control for Fan Coil Units (p/n 0020-023) (p/n 0020-024)
- 0020-031 Speed Control for Fan Coil Units (p/n 0020-022)

Fan Coil Unit, 50k Btu

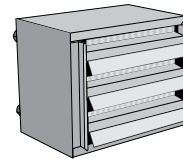

50k Btu fan coil unit (3/4" FIP) includes housing, fan, heat exchanger coil and louvers. Btu range: 20k-50k Btu. Approximate dimensions: 16-1/4" x 17" x 13-1/4". Motor: 70 watts.

- 2900544 Fan Coil Unit, 50k Btu
- 2900610 Replacement Fan, motor and shield, 50k Btu, for 29000544

Fan Coil Unit, 100k Btu

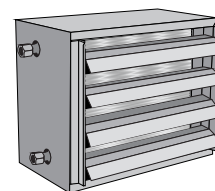

100k Btu fan coil unit (3/4" FIP) includes housing, fan, heat exchanger coil and louvers. Btu range: 40k-100k Btu. Approximate dimensions: 21" x 19" x 17". Motor: 180 watts.

- 2900545 Fan Coil Unit, 100k Btu
- 2900611 Replacement Fan, motor and shield, 100k Btu, for 29000545

Fan Coil Unit, 220k Btu

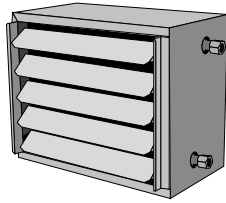

220k Btu fan coil unit (3/4" FIP) includes housing, fan, heat exchanger coil and louvers. Btu range: 80k-220k Btu. Approximate dimensions: 31" x 18" x 25". Motor: 330 watts.

- 2900546 Fan Coil Unit, 220k Btu
- 2900612 Replacement Fan, motor and shield, 220k Btu, for 29000546

Air Handler Cabinet

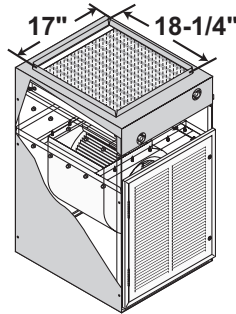

Two sizes allow multiple applications from 100k Btu to 220k Btu (refer to the chart for dimensions and heat exchanger coil ranges). Cabinets are standard with front water access; kits are available for converting to rear water access.

NOTE: Blower & Motor and Heat Exchanger Coil are sold separately. Air Handler Cabinet door is capable of holding a filter (not included). Some assembly will be required. If utilizing an existing 24-volt thermostat to control blower, a Fan Center Relay (p/n 515) must be used.

p/n	Dimensions (in.)	Heat Exch. Coil Range	Blower & Motor	Water Access
301	36 x 20 x 23 Filter (not included): 16 x 20	100k-140k Btu	1/4-hp	Front
303	39 x 25 x 28 Filter (not included): 20 x 20	185k-220k Btu	1-hp	Front

301	Air Handler Cabinet, 100k-140k Btu, front access			
3822	Kit for 301 - back water access			
303	Air Handler Cabinet, 185k-220k Btu, front access			
3825	Kit for 303 - back water access			

Blower & Motor

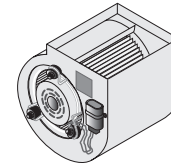

- 203 Blower & Motor, 1/15-hp
- 154 Blower & Motor, 1/4-hp, 3-speed fan
- 208 Blower & Motor, 1-hp, 3-speed fan

p/n 203 1/15 hp 115V	CFM (cubic feet per minute)							
	FREE AIR	1/8" SP	1/4" SP	3/8" SP	1/2" SP	3/4" SP	1" SP	1 1/4" SP
1530 rpm (1-speed)	465	430	397	357	308	N/A	N/A	N/A

p/n 154 1/4 hp 115V	CFM (cubic feet per minute)					
	FREE AIR	1/4" SP	1/2" SP	3/4" SP	1" SP	1 1/4" SP
LOW speed	708	808	800	593	194	
MED. speed	963	1063	1020	708	224	
HIGH speed	1353	1349	1287	1014	250	

p/n 208 1 hp 115V	CFM (cubic feet per minute)					
	1.2" SP	1.3" SP	1.4" SP	1.5" SP	1.6" SP	1.7" SP
LOW speed (1038 rpm)	2248	2143	2032	1890	1085	1498
MED. speed (1070 rpm)	2480	2373	2218	2084	1910	1696
HIGH speed (1097 rpm)	2701	2522	2373	2231	2057	1851

SP=static pressure, hp=horsepower

Heat Exchangers - Water-to-Air

Heat Exchanger Coils

p/n	Output (Btu)	Approx. Plenum Size (in.)	Dimensions			3/4" FPT Outlets	1" Sweat Outlets
			Length (in.)	Width (in.)	Depth (in.)		
0020-041	75,000	16 x 18	17-1/2	15-1/4	5-1/2	-	Straight
0020-043	100,000	18 x 20	19-5/8	18	5-1/2	-	Straight
5600029	100,000	17 x 19	19	16-1/2	4-1/8	-	Straight
0020-044	125,000	18 x 22	21-3/4	18	5-1/2	-	Straight
0020-045	140,000	19 x 23	22-3/8	19	5-1/2	-	Straight
0020-046	160,000	18 x 27	26-5/8	18	5-1/2	-	Straight
0020-047	200,000	24 x 28	27-5/8	24	5-1/2	-	Straight
287	50,000	13 x 14	14	12-3/4	4-1/8	90°	-
109	80,000	13 x 18	18	12-3/4	4-1/8	Straight	-
102	95,000	15 x 20	20	15	4-1/8	Straight	-
106	100,000	17 x 19	19	16-1/2	4-1/8	Straight	-
107	125,000	18 x 20	20	17-3/4	4-1/8	Straight	-
704	125,000	18 x 20	20	17-3/4	4-1/8	90°	-
108	140,000	20 x 20	21	19	4-1/8	Straight	-
110	185,000	23 x 23	24	19	4-1/8	Straight	-
111	220,000	24 x 24	26	24	4-1/8	Straight	-

Water-to-air heat exchanger coils are available in different sizes with different Btu outputs. Be sure to check the dimensions of the coil and the approximate plenum size, in addition to the outlet configuration.

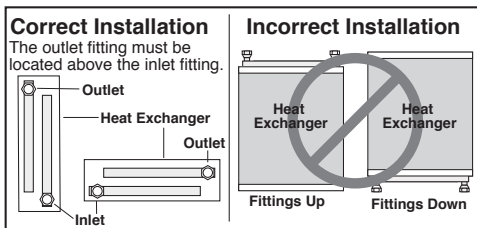

Heat Exchanger Coil (100k Btu)

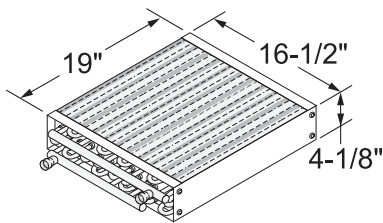

Heat Exchanger Coil (100k Btu) - Water-to-air heat exchanger coil with straight 1" sweat outlets. Used in forced-air furnaces with plenum size of approximately 17" x 18". Dimensions: 16-1/2" x 19" x 4-1/8".

5600029 Heat Exchanger Coil, 100k Btu, 1" Sweat



- 0020-041 Heat Exchanger Coil, 75k Btu (15-1/4" x 17-1/2" x 5-1/2") 1" Ports
- 0020-043 Heat Exchanger Coil, 100k Btu (18" x 19-5/8" x 5-1/2") 1" Ports
- 0020-044 Heat Exchanger Coil, 125k Btu (18" x 21-3/4" x 5-1/2") 1" Ports
- 0020-045 Heat Exchanger Coil, 140k Btu (19" x 22-3/8" x 5-1/2") 1" Ports
- 0020-046 Heat Exchanger Coil, 160k Btu (18" x 26-5/8" x 5-1/2") 1" Ports
- 0020-047 Heat Exchanger Coil, 200k Btu (24" x 27-5/8" x 5-1/2") 1" Ports

Heat Exchangers - Water-to-Air

Heat Exchanger Coil (50k Btu)

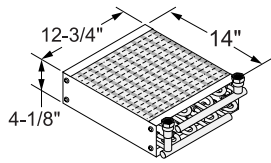

Water-to-air heat exchanger coil with 90° 3/4" female pipe thread (FPT) outlets. Dimensions: 2-3/4" x 14" x 4-1/8".

287 Heat Exchanger Coil, 50k Btu

Heat Exchanger Coil (80k Btu)

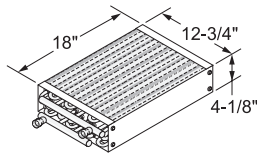

Heat Exchanger Coil (80k Btu) - Water-to-air heat exchanger coil with straight 3/4" FPT outlets. Used in forced-air furnaces with plenum size of approximately 13" x 18". Dimensions: 12-3/4" x 18" x 4-1/8".

109 Heat Exchanger Coil, 80k Btu

Heat Exchanger Coil (95k Btu)

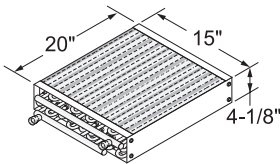

Water-to-air heat exchanger coils with straight 3/4" FPT outlets. Used in forced-air furnaces with plenum size of approximately 15" x 18". Dimensions: 15" x 20" x 4-1/8".

102 Heat Exchanger Coil, 95k Btu

Heat Exchanger Coil (100k Btu)

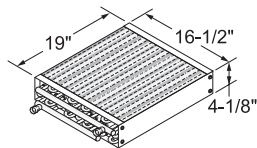

Heat Exchanger Coil (100k Btu) - Water-to-air heat exchanger coil with straight 3/4" FPT outlets. Used in forced-air furnaces with plenum size of approximately 17" x 18". Dimensions: 16-1/2" x 19" x 4-1/8".

106 Heat Exchanger Coil, 100k Btu. 3/4" FPT

Heat Exchanger Coil (125k Btu)

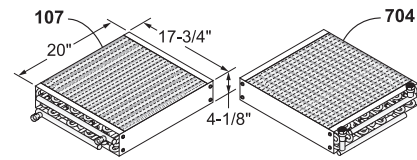

Water-to-air heat exchanger coil with straight (p/n 107) or 90-degree (p/n 704) 3/4" FPT outlets. Used in forced-air furnaces with plenum size from approximately 18" x 18" to 18" x 20". Dimensions: 17-3/4" x 20" x 4-1/8".

107 Heat Exchanger Coil, 125k Btu, straight outlets
704 Heat Exchanger Coil, 125k Btu, 90° outlets

Heat Exchanger Coil (140k Btu)

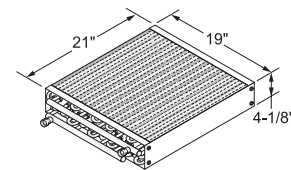

Water-to-air heat exchanger coil with straight 3/4" FPT outlets. Used in forced-air furnaces with plenum size of approximately 20" x 20". Dimensions: 19" x 21" x 4-1/8".

108 Heat Exchanger Coil, 140k Btu

Heat Exchanger Coil (185k Btu)

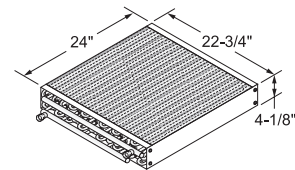

Water-to-air heat exchanger coil with straight 3/4" FPT outlets. Used in forced-air furnaces with plenum size of approximately 23" x 23". Dimensions: 22-3/4" x 24" x 4-1/8".

110 Heat Exchanger Coil, 185k Btu

Heat Exchanger Coil (220k Btu)

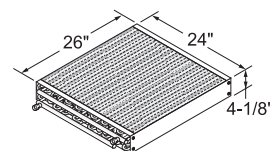

Water-to-air heat exchanger coil with straight 3/4" FPT outlets. Used in forced-air furnaces with plenum size of approximately 24" x 24". Dimensions: 24" x 26" x 4-1/8".

111 Heat Exchanger Coil, 220k Btu

Heat Exchangers - Water-to-Water

Plate Exchangers



- 0020-051 Plate Exchanger, 4.57" x 11.26"-20, 1" Port
- 0020-052 Plate Exchanger, 4.57" x 11.26"-30, 1" Port
- 0020-053 Plate Exchanger, 4.57" x 11.26"-50, 1" Port
- 0020-054 Plate Exchanger, 4.57" x 11.26"-60, 1-1/4" Port

Heat Exchanger, Plate

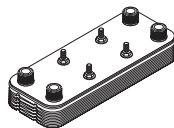

The Plate Heat Exchanger is a compact, high-performance, water-to-water, continuous flow heat exchanger with MPT ports. Units are 316L stainless, copper-brazed.

p/n	Typical Application
5600003	Water Heaters
5600004	Boilers up to 100k Btu
5600001	Boilers 100k-175k Btu
5600002	Boilers 175k-250k Btu
5634	
5600019	

- 5600003 Plate Exchanger, 5 x 12-6, 3/4" Port
- 5600004 Plate Exchanger, 5 x 12-30, 3/4" Port
- 5600001 Plate Exchanger, 5 x 12-50, 1-1/4" Port
- 5600002 Plate Exchanger, 5 x 12-70, 1-1/4" Port
- 5634 Plate Exchanger, 10 x 20-40, 1-1/2" Port
- 5600019 Plate Exchanger, 10 x 20-55, 1-1/4" Port

NOTE: Also see Swimming Pool Heat Exchangers (p/n 5600005 through 5600015).

Mounting Bracket, Plate Heat Exchanger

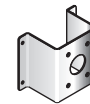

Mounts most 5" x 12" Plate Heat Exchangers (30 or less) with mounting studs to a wall or similar surface.

- 5807-011 Plate Mounting Bracket

Mounting Kit, Plate Heat Exchanger

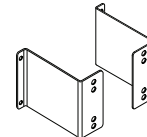

Mounts most 5x12 Plate Heat Exchangers (40 or more) with mounting studs to a wall or similar surface. Includes two mounting brackets.

- 2500299 Heat Exchanger Mounting Kit

Mounting Kit, Plate Heat Exchanger, 5x12, Universal

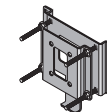

Universal mounting kit for 5x12 plate exchangers.

- 1097 Universal 5x12 Plate Heat Exchanger Mounting Kit

Water-to-Water Heat Exchanger for Domestic Water Heater

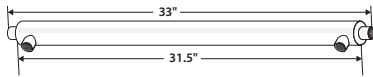

The Water-to-Water Heat Exchanger is a stainless steel water-to-water, domestic water heat exchanger with 3/4" FIP end and side ports. Install on existing water heater for thermal circulating heat transfer. Fittings Kit (p/n 2053) or Push-fit Fittings Kit (9263) are available separately for easy installation.

5600018 Water-to-Water Heat Exchanger, 33"

Fittings Kit, Water Heater - for Water-to-Water Heat Exchanger

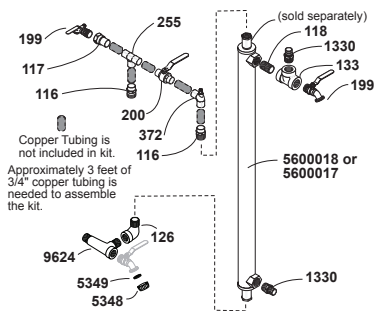

Used to install the Water-to-Water Heat Exchanger (p/n 5600018) on existing domestic water heater for thermal circulating heat transfer. Water-to-water heat exchanger is sold separately.

2053 Fittings Kit

Fittings Kit, Push-fit - for Water-to-Water Heat Exchanger

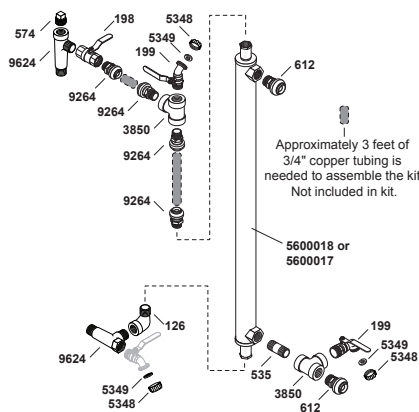

Used to install the Water-to-Water Heat Exchanger (p/n 5600018) on existing domestic water heater for thermal circulating heat transfer. Water-to-water heat exchanger is sold separately.

9263 Push-fit Fittings Water Heater Kit

Heat Exchangers - Water-to-Water

Water Heater Tube Kit



0020-058 Water Heater Tube Kit

Heat Exchanger, Stainless 316L - for Swimming Pool

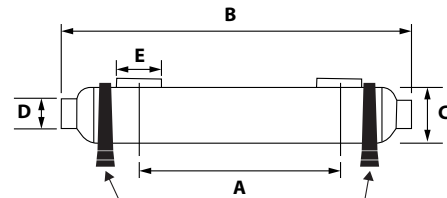

Mounting brackets are included

Stainless steel exchangers are used as hot tub or swimming pool heat exchangers. Other applications include snow melt or solar heating. Not recommended for use with salt chlorinated pools or hot tubs.

Mounting brackets are included for horizontal or vertical mounting. Should always be installed with the mounting bracket fixed to a wall, ceiling or floor to prevent damage from vibrations or water hammer.

p/n	Btu Rating	Pool Capacity (U.S. gallons)
5600005	55,000	3,960
5600006	155,000	11,900
5600007	300,000	23,800
5600008	360,000	29,000
5600009	600,000	47,500
5600010	1,200,000	95,100

Exchanger Dimensions

p/n	A (in.)	B (in.)	C (in.)	D (in.)	E (in.)
5600005	7.6	13.3	2.5	1	3/4
5600006	9.2	15.9	3.1	1	1-1/2
5600007	20.5	27.6	3.1	1-1/2	2
5600008	28	35	3.1	1-1/2	2
5600009	25.4	33.9	4.3	2	2-1/2
5600010	25.9	35.2	5	2	2-1/2

- 5600005 Pool Heat Exchanger, 316L, 55k Btu
- 5600006 Pool Heat Exchanger, 316L, 155k Btu
- 5600007 Pool Heat Exchanger, 316L, 300k Btu
- 5600008 Pool Heat Exchanger, 316L, 360k Btu
- 5600009 Pool Heat Exchanger, 316L, 600k Btu
- 5600010 Pool Heat Exchanger, 316L, 1200k Btu

Heat Exchangers - Water-to-Water

Heat Exchanger, Titanium - for Swimming Pool

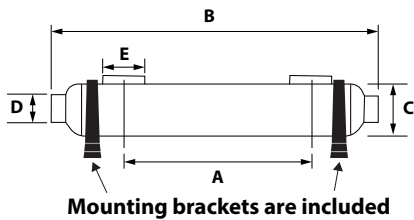

Ideal for swimming pools with salt water or where salt generator/chlorinators are used. Mounting brackets are included for horizontal or vertical mounting. Should always be installed with the mounting bracket fixed to a wall, ceiling or floor to prevent damage from vibrations or water hammer.

p/n	Btu Rating	Pool Capacity (U.S. gallons)
5600011	55,000	3,960
5600012	155,000	11,900
5600013	300,000	23,800
5600014	360,000	29,000
5600015	600,000	47,500

Exchanger Dimensions

p/n	A (in.)	B (in.)	C (in.)	D (in.)	E (in.)
5600011	7.6	13.3	2.5	1	3/4
5600012	9.2	15.9	3.1	1	1-1/2
5600013	20.5	27.6	3.1	1-1/2	2
5600014	28	35	3.1	1-1/2	2
5600015	25.4	33.9	4.3	2	2-1/2

- 5600011 Pool Heat Exchanger, Titanium, 55k Btu
- 5600012 Pool Heat Exchanger, Titanium, 155k Btu
- 5600013 Pool Heat Exchanger, Titanium, 300k Btu
- 5600014 Pool Heat Exchanger, Titanium, 360k Btu
- 5600015 Pool Heat Exchanger, Titanium, 600k Btu

Mounting Brackets - Swimming Pool Heat Exchangers



Replacement mounting brackets (2 per set) for Stainless 316L and Titanium Swimming Pool Heat Exchangers.

- 3104665 Mounting Bracket, 55k Btu Pool Heat Exchangers
- 3104940 Mounting Bracket, 155k/300k/360k Btu Pool Heat Exchangers
- 3104941 Mounting Bracket, 600k Btu Pool Heat Exchangers
- 3104942 Mounting Bracket, 1200k Btu Pool Heat Exchangers

Filter & Fill Valve Kits



- 0020-291 Fill Valve and Inline Filter, Kit, Push-fit
- 0020-325 Fill Valve and Inline T-Strainer, Crimp
- 0020-261 Filter, Inline Screen - 1" FPT - Black

Y-Strainer

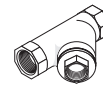

Y-Strainer with 0.20 mesh and FIP fittings. Recommended when installing plate-style heat exchangers. For 3/4" Y-Strainer, use 1/2" Brass Pipe Plug (p/n 6557) for cleanout port. For 1" Y-Strainer, use 3/4" Brass Pipe Plug (p/n 574) for cleanout port.

- 1694 Y-Strainer, 1-1/4" - Black
- 1695 Y-Strainer, 3/4" - Brass

Heat Exchangers - Convection

Radiant Baseboard Heaters, Complete



- 0020-070 Baseboard, Complete, 2'
- 0020-072 Baseboard, Complete, 4'
- 0020-074 Baseboard, Complete, 6'
- 0020-078 Baseboard End Cap, Left
- 0020-079 Baseboard End Cap, Right
- 0020-081 Baseboard Corner, Outside

Kickspace Heaters



- 0020-086 Heater, Kickspace, TK-70, 5638 Btu
- 0020-087 Heater, Kickspace, TK-90, 7350 Btu
- 0020-088 Wall Mount Kit, Recessed - Kickspace Heater
- 0020-089 Wall Mount Kit, Surface - Kickspace Heater

Panel Radiators

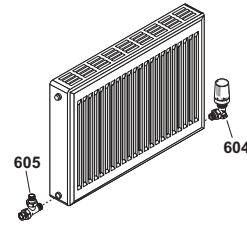

Type 21G Double Panel Single Convactor and Type 22G Double Convactor panel radiators in various sizes and Btu output. Valves (p/n 604, 605 are sold separately).

- No electricity required, no thermostats, no extra pumps
- Easy installation - includes mounting bracket and thread sealer

p/n	Baseboard Equivalent	Output (Btu/hr)	Fan Convactor Equivalent
5600021	6 feet	3,700	N/A
5600022	10 feet	5,600	6777, 6774, 6839
5600023	14 feet	7,300	6776, 6780
603	18 feet	10,000	6773

- 5600021 Panel Radiator, 32" x 16"
- 5600022 Panel Radiator, 36" x 24"
- 5600023 Panel Radiator, 48" x 24"
- 603 Panel Radiator, 55-1/4" x 24"

Valve Bodies, Thermostatic Radiator

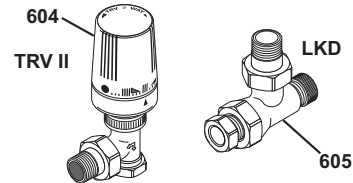

Each valve body is threaded for nominal iron pipe threads and also comes with a compression nut and ferrule. Replacement head only is part number 5000378.

- 604 TRV II Valve Body and Head, 1/2" Vertical
- 605 LKD Valve Body with No Cap, 1/2" Preset Flow Rate

Valve Head, TRV II



Replacement valve head for 604 TRV II Valve Body and Head, 1/2" vertical.

- 5000378 Valve Head, 1/2" Vertical, TRV II

Piping - ThermoPEX

ThermoPEX with 1" or 1-1/4" PEX



ThermoPEX is flexible pre-insulated piping consisting of two waterproof oxygen barrier PEX-A lines (supply and return) protected by polyurethane closed cell foam insulation and a thick, durable, waterproof polyethylene outer jacket. It is the ideal insulated piping for use with outdoor wood furnaces.

Available with 1" Central PEX in 100-ft, 200-ft or 800-ft rolls, or with 1-1/4" PEX in 100-ft or 300-ft rolls.

2441	ThermoPEX, 1", 100' Roll
5700034	ThermoPEX, 1", 200' Roll
2491	ThermoPEX, 1", 800' Roll
2799	ThermoPEX, 1-1/4", 100' Roll
2492	ThermoPEX, 1-1/4", 300' Roll

ThermoPEX Coupling Kit - 1" and 1-1/4"

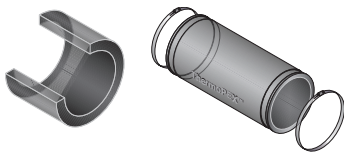

Twelve-inch rubber splice is used to join two ends of ThermoPEX together. Includes band clamps. Fittings and crimp rings for joining the PEX lines are sold separately.

2447	ThermoPEX Coupling Kit, 1"
2495	ThermoPEX Coupling Kit, 1-1/4"
1333	PEX Coupling, 1"

ThermoPEX with 25mm PEX

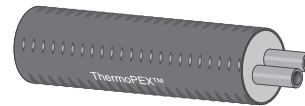

ThermoPEX with two 25mm waterproof oxygen barrier PEX-A lines (supply and return) is more flexible and easier to haul and ship. It's ideal for shorter runs and for the do-it-yourselfers.

The 55' roll (p/n 5700047) is UPS shippable. All rolls except the 500' roll can be shipped via Spee-Dee.

5700047	ThermoPEX, 25mm, 55' Roll
5700043	ThermoPEX, 25mm, 60' Roll
5700046	ThermoPEX, 25mm, 95' Roll
5700045	ThermoPEX, 25mm, 500' Roll

ThermoPEX Coupling Kit - 25mm

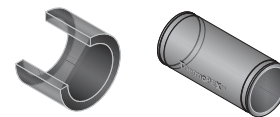

Twelve-inch rubber splice is used to join two ends of ThermoPEX together. Includes band clamps. Fittings and crimp rings for joining the PEX lines are sold separately.

2500172	ThermoPEX Coupling Kit, 25mm
---------	------------------------------

ThermoPEX Termination Cap



Fits snugly over each end to protect and seal the insulation from water. Includes band clamps.

5500014	ThermoPEX Cap, 25mm
2443	ThermoPEX Cap, 1"
2494	ThermoPEX Cap, 1-1/4"

Piping - EZ Lay and 1-1/4" PEX Crimp Fittings

E-Z Lay Insulated Pipe

Water lines are insulated with commercial-grade EPS insulation in a 4" (5" for 5-wrap pipe) commercial-grade corrugated tile. Includes one blue PEX line, one red PEX line, two end caps and string for pulling an electrical, thermostat or tracing wire through the corrugated tile.

Available in rolls or by the foot (see part numbers for prices per foot). The 5-wrap pipe is only available by the foot. When ordering by the foot, please be sure to add 5 feet on each end when measuring the distance needed for the pipe.



1" PEX Lines - 3-Wrap

- 0020-650 E-Z Lay 3-wrap Insulated Pipe, 1" x 250' Roll
- 0020-651 E-Z Lay 3-wrap Insulated Pipe (regular non-barrier), 1" - per foot
- 0020-654 E-Z Lay 3-wrap Insulated Pipe, 1" x 100' Roll
- 0020-655 E-Z Lay 3-wrap Insulated Pipe, (oxygen barrier) 1" - per foot

1-1/4" PEX Lines - 3-Wrap and Fittings

- 0020-652 E-Z Lay 3-wrap Insulated Pipe, 1-1/4" x 250' Roll
- 0020-653 E-Z Lay 3-wrap Insulated Pipe, 1-1/4" - per foot

Fittings, 1-1/4" PEX (CTS)

The 1-1/4" PEX lines in the E-Z Lay are 1-1/4" CTS (copper tubing size), SDR-9; fittings here are for 1-1/4" CTS.

- 0020-572 PEX Crimp Coupling, 1-1/4"
- 0020-575 PEX Adapter, 1-1/4" MPT x 1-1/4" PEX
- 0020-576 PEX 90° Crimp Elbow, 1-1/4"
- 0020-577 PEX Crimp Tee, 1-1/4"
- 0020-578 PEX Crimp Plug, 1-1/4"
- 0020-579 PEX Crimp Tee, 1-1/4" x 1-1/4" x 1"
- 0020-580 PEX Crimp Ring, 1-1/4"

1" PEX Lines - 5-Wrap



0020-656 E-Z Lay 5-wrap Insulated Pipe, 1" - per foot

PEX Tubing Technical Specifications

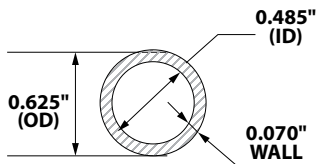

1/2" CTS

Central PEX / PureLink / HeatLink
SDR = 9

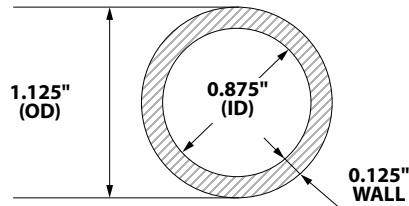

1" CTS

ThermoPEX / Central PEX / E-Z Lay Pipe
SDR = 9

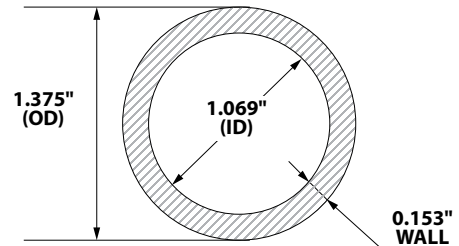

1-1/4" CTS

E-Z Lay Pipe
SDR = 9

PEX Tubing Size (CTS/Nominal)	Outside Diameter (OD)	Minimum Wall Thickness	Inside Diameter (ID)
1/2"	0.625"	0.070"	0.485"
1"	1.125"	0.125"	0.875"
1-1/4"	1.375"	0.153"	1.069"

Notes:

1. PEX tubing sizes are denoted by CTS (copper tubing size), not OD (Outside Diameter) or ID (Inside Diameter).
2. OD of PEX, copper and CPVC pipe with the same size (CTS) is the same. This is why push fittings can be used with all of these pipes.
3. PEX made to US standards must comply with a SDR-9 (Standard Dimension Ratio), which is the ratio of OD (Outside Diameter) to pipe wall thickness (9:1). Exceptions are nominal sizes 1/2" and below.

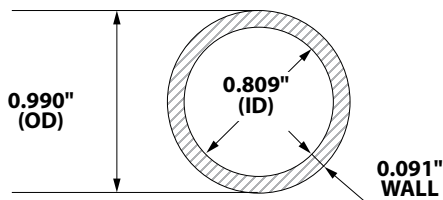

25mm

ThermoPEX
SDR = 11

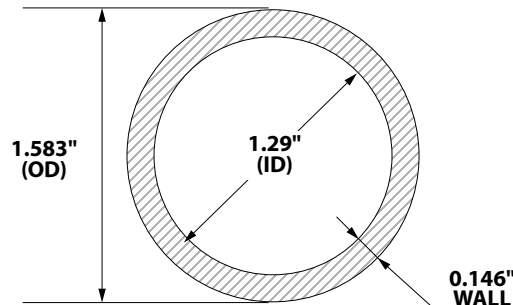

1-1/4"

ThermoPEX / Central PEX
SDR = 11

PEX Tubing Size (Nominal)	Outside Diameter (OD)	Minimum Wall Thickness	Inside Diameter (ID)
25mm	0.990"	0.091"	0.809"
1-1/4"	1.583"	0.146"	1.29"

Notes:

1. PEX with a SDR-11 (Standard Dimension Ratio) are NOT compatible with CTS (copper tubing size) fittings.
2. 25mm PEX and 1-1/4" PEX used in ThermoPEX are SDR-11 (Standard Dimension Ratio), which is the ratio of OD (Outside Diameter) to pipe wall thickness (11:1).

Central PEX 1" Pipe

High-density, non-oxygen barrier PEX-B, cross-link pipe, rated for temperatures to 180°F at 100 psi. Note that color has changed from green to red.

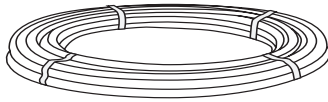

- 1311 Central PEX 1" Pipe, 100'
- 1312 Central PEX 1" Pipe, 200'
- 1313 Central PEX 1" Pipe, 300'
- 1314 Central PEX 1" Pipe, 500'

Central PEX 1" Pipe Sections

Central PEX 1" Pipe, non-oxygen barrier PEX-B, in straight 8-ft sections.

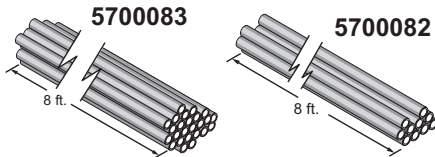

- 5700082 Central PEX 1" Pipe, 8' straight section, 10 per bag
- 5700083 Central PEX 1" Pipe, 8' straight section, 25 per bag

PEX 1-1/4" Pipe (SDR-11)

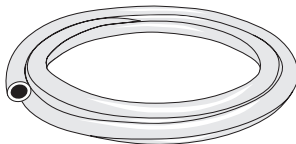

High-density, oxygen barrier PEX-A, cross-link pipe, rated for 180°F.

NOTE: This PEX is SDR-11 and is not compatible with 1-1/4" CTS fittings. Use only Brass Fittings (p/n 380, 381 and 382) or Brass Clamp Fitting (p/n 5643) for this 1-1/4" PEX Pipe.

- 5670 PEX 1-1/4" Pipe, 150'
- 386 PEX 1-1/4" Pipe, 328'

Fittings, Brass - for 1-1/4" PEX Pipe (SDR-11)

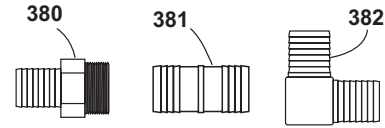

Brass fittings for 1-1/4" PEX pipe (SDR-11). To ease installation, it is recommended that a heat gun be used on the 1-1/4" PEX pipe. Not compatible with 1-1/4" CTS PEX.

- 380 Male Adapter, 1-1/4" barb x 1-1/4" MIP
- 381 Brass Coupling, 1-1/4" barb x 1-1/4" barb
- 382 Brass Elbow, 1-1/4" barb x 1-1/4" barb

Fittings , PEX

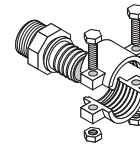

Brass adapter clamps for PEX pipe.

- 5642 Brass Clamp Fittings, 1"
- 5643 Brass Clamp Fittings, 1-1/4" PEX Pipe (SDR-11)

Coupling, 25mm PEX

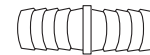

For coupling two 25mm Central PEX pipe ends.

- 5000462 PEX Coupling, 25mm

Couplings, 1/2" and 1" PEX



For coupling two Central PEX pipe ends.

- 1339 PEX Coupling, 1/2"
- 1333 PEX Coupling, 1"

Circulators

Pump, Taco - 006 Series

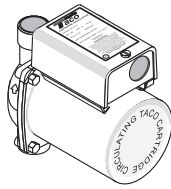

Taco 006 Bronze Circulation Pump for domestic water systems. No flange required, 3/4" sweat connection. Power Supply Cord (p/n 556) sold separately.

size	hp	Amp	Watt	Head (ft)	Volume (gal/min)
006	1/40	0.52	59.8	9	10
175	Taco 006 Bronze Pump				

Pump, Taco - 007 Series



The Taco 007 circulator pump is one of the industry's top-selling hydronic circulators, and for good reason. It features a unique cartridge design that's completely field serviceable plus a self-lubricating system that's virtually maintenance-free. Includes O-rings. Power Supply Cord (p/n 556) sold separately.

size	hp	Amp	Watt	Head (ft)	Volume (gal/min)
007	1/25	0.70	80.50	11	20
007 Priority	1/25	0.70	81.65	11	20
5800004	Taco 007 Circulating Pump				
5800011	Taco 007 Priority Pump				

Pump, Taco - 009 Series

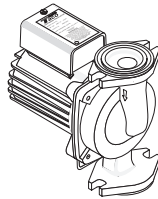

Taco 009 Circulation Pumps require flange kit (not included). Includes O-rings. Power Supply Cord (p/n 556) sold separately.

size	hp	Amp	Watt	Head (ft)	Volume (gal/min)
009	1/8	1.40	161	34	8
5800006	Taco 009 Pump				

Pump, Taco - 0011 Series



The Taco High Velocity Series 0011 Cartridge Circulator is specifically designed for high-head/medium-flow applications in large residential/light commercial closed-loop hydronic heating systems. Power Supply Cord (p/n 556) sold separately.

size	hp	Amp	Watt	Head (ft)	Volume (gal/min)
0011	1/8	1.76	202.4	31	31
0020-351	Taco 0011 Circulating Pump				

Pump, Taco - 014 Series

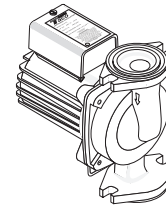

Taco 014 Circulation Pumps require flange kit (not included). Includes O-rings. Power Supply Cord (p/n 556) sold separately.

size	hp	Amp	Watt	Head (ft)	Volume (gal/min)
014	1/8	1.55	178	22	32
5800008	Taco 014 Pump				

Pump, Taco - 2400-20



Taco 2400 series high capacity circulators are specifically designed for quiet, efficient, dependable operation in a wide range of medium to high flow/head applications. Power Supply Cord (p/n 556) sold separately.

size	hp	Amp	Watt	Head (ft)	Volume (gal/min)
2400-20	1/6	1.90 (115V) 1.00 (230V)	184	46	90
0020-345	Taco 2400-20 Circulating Pump				

Pump, Taco - Viridian® VR1816

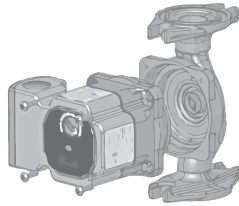

The Taco Viridian VR1816 pump is an infinitely-variable speed, high-efficiency wet rotor circulator with an ECM permanent magnet motor.

- Infinitely-variable fixed speed to fine-tune any zone
- Self-adjusting constant pressure for zone valve applications
- Self-adjusting proportional pressure for panel radiators and thermostatic radiator valves
- 115V, 60 Hz single phase
- 1590-4830 RPM

Model	Max. Amp	Watt	Max. Shutoff Head (ft)	Max. Flow (gal/min)
VR1816F	0.54	4-44	18	16

5800023 Taco Viridian Pump, VR1816F

Pump, Taco - Viridian® VT2218



The Taco Viridian VT2218 pump is a temperature sensing, variable speed wet rotor circulator with an ECM permanent magnet motor. Operating modes include Delta-T differential temperature, 4 fixed speeds, set point heat, set point cool and boiler protection.

- Delta-T operation maximizes system efficiency and comfort
- High-efficiency ECM motor uses up to 85% less electricity
- LCD displays operating mode, temperature or speed setting, watts, supply & return temperatures
- Easy to program and install
- 110-120V, 50/60 Hz single phase
- 1650-4200 RPM

Model	Max. Amp	Watt	Max. Shutoff Head (ft)	Max. Flow (gal/min)
VT2218F	0.67	9-58	22	18

5800025 Taco Viridian Pump, VT2218

Pump, Taco - 0015e3™

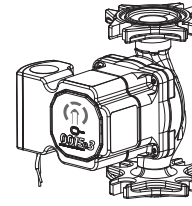

The 0015e3 is a variable speed, high-efficiency wet rotor circulator with an ECM permanent magnet motor. It's ideal for hydronic systems zoned with circulators or zone valves. With three easy settings, the 0015e3 delivers performance, reliability and ease-of-installation.

- Bio Barrier® protects the pump from system contaminants
- SureStart™ automatic unblocking and air purging mode
- High-efficiency ECM motor uses up to 85% less electricity
- IFC® (Integral Flow Check) is included
- 3 easy settings: LOW (5 ft head), MEDIUM (10 ft head) HIGH (18 ft head); 16 gpm max flow
- Dual electrical knockouts and 6" stranded wire leads for no-fumble wiring
- Double insulated; no ground wire needed
- Whisper quiet operation

Model	Max. Amp	Watt	Max. Shutoff Head (ft)	Max. Flow (gal/min)
0015e3	0.54	44	18	16

5800033 Pump, Taco 0015e3

Pump Cartridges



0020-357

- 222 Replacement Cartridge, 006 Series Pumps
- 0020-357 Replacement Cartridge, Taco 007 Pump
- 5800007 Replacement Cartridge, 009 Series Pumps
- 5800010 Replacement Cartridge, Bronze, 011 Series Pumps

Circulators & Related

Replacement Seal Kits and Gaskets

- 5800034 O-Ring, Cartridge, Taco 007/009 (set of 2)
- 0020-346 Replacement Seal Kit, Taco 2400-20 pump

542



Compatible with Taco 007 series of pumps.

- 542 O-Ring Set, Taco Pump Flange

Flanges, Pump

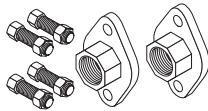

Each kit includes set of two female iron pipe (FIP) pump flanges. One set is used with each pump. Most installations use Pump Flange Kit, 3/4" (p/n 119).

- 119 Pump Flange Kit, 3/4"
- 194 Pump Flange Kit, 1"
- 5800019 Pump Flange Kit, 1-1/4"

Flange Kit, Isolation

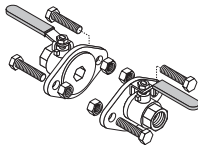

Kit includes flanges, nuts and bolts. Full port, valved flange body.

- 224 "Free Floating" Flange Kit, 3/4"
- 225 Isolation Flange Kit, 1-1/4"



0020-365

- 0020-365 Gasket, Isolation Flanges (each)



0020-366

- 0020-366 Pump Isolation Flange, 1"

NOTE: Price is for one flange only.

Flange, 3/4" Isolation - with Drain Valve

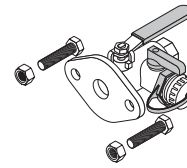

Includes flange, nuts and bolts.

- 226 Isolation Flange with Drain Valve, 3/4"

NOTE: Price is for one flange only.

Cord, Power Supply



May be used to wire pumps when installed on furnaces. Power Supply Cord (p/n 556) Includes strain relief; Power Supply Cord (p/n 555) does not.

- 556 Power Supply Cord, 32"
- 555 Power Supply Cord, 48"

Mount Kit, Wall - Taco Pump

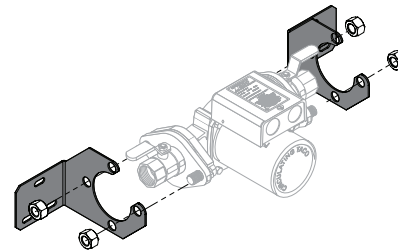

Brackets for supporting and securing Taco pump and flanges to a wall. Figure shows one possible installation scenario. Pump, flanges and mounting hardware are not included.

- 1366 Pump Wall Mount Kit

Manifold Kits

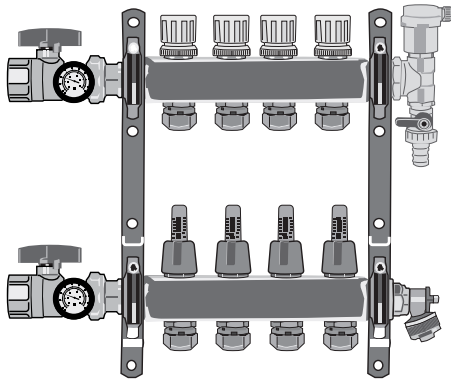

4-Loop shown for illustration purposes

Commonly used for radiant floor heat systems, stainless steel radiant manifold kits are available in various loop configurations for use with 1/2" PEX*.

Each kit includes:

- See-through body flow meters with adjustable flow rates
- Isolation ball valves with 1" NPT fitting
- Temperature gauge for each isolation valve
- Automatic float vent
- 1/2" PEX compression connectors*
- Mounting brackets

- 2900552 Manifold Kit, 2-Loop
- 2900553 Manifold Kit, 3-Loop
- 2900554 Manifold Kit, 4-Loop
- 2900556 Manifold Kit, 6-Loop
- 2900558 Manifold Kit, 8-Loop
- 2900560 Manifold Kit, 10-Loop
- 2900562 Manifold Kit, 12-Loop
- 5000673 O-ring, Manifold

Manifold Kit Connectors



For use with Stainless Steel Radiant Manifold Kits.

- 2900563 Connector, Compression, 1/2" PEX
- 2900564 Connector, Compression, 1/2" PEX-AL-PEX - **ONLY FOR ALUMINUM CORE PEX**

Adapter, Female 1" NPT - for Manifold Kits



For use with Stainless Steel Radiant Manifold Kits.

- 2900614 Adapter, Manifold, Female 1" NPT

Cap - for Manifold Kits



Manifold Loop Cap can be used with Stainless Steel Radiant Manifold Kits.

- 2900551 Loop Cap, Manifold

Gauge, Temperature - for Manifold Kits



Manifold Temperature Gauge can be used with Stainless Steel Radiant Manifold Kits.

- 2900596 Temperature Gauge, Manifold

Actuator, Thermal

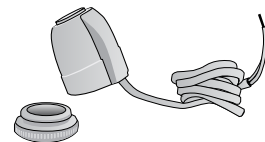

Optional Thermal Actuator (compatible with Stainless Steel Radiant Manifold Kits) is available with either 2-wire or 4-wire configuration. 2-wire provides individual loop flow control on multi-zoned manifold. 4-wire also features end switch for activation of a pump.

- 2900549 Thermal Actuator, 2-wire
- 2900550 Thermal Actuator, 4-wire

HeatLink Products

Blue PureLink® Plus UV Stabilized PEX-a Tubing



High molecular crosslinked polyethylene (PEX) with minimum bending radius of 6x the diameter at 68°F (20°C). Maximum operating temperature 180°F @ 100 psi (82°C @ 7 bar). Blue printing for identification of cold water lines. The PureLink® Plus PEX-a tubing may be used with fittings that are compliant with ASTM F1807/F1960/F2080/F2098/F2159 standards.

20905 PureLink Non-Barrier PEX-A, 1/2" x 1000'

HeatLink® PEX-a Tubing with O2 Barrier



High molecular cross-linked polyethylene (PEX-a) with minimum bending radii of 6x the diameter at 68°F (20°C). Maximum operating temperature: 180°F @ 100 PSI (82°C @ 690 kPa). Covered by a twenty-five year manufacturer's limited warranty. Comes with oxygen diffusion barrier which prevents oxygen from entering the heating system through the tubing wall.

94305 HeatLink O2 Barrier PEX-A Tubing, 1/2" x 300'

Central PEX 1/2" Pipe

High-density, oxygen barrier PEX-B, cross-link pipe. Rated for temperatures to 180°F at 100 psi. Available in rolls up to 1000 ft long. Excellent for radiant floor heating applications.

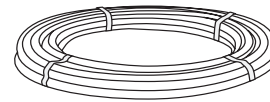

- 1320 Central PEX 1/2" Pipe, 300'
- 1321 Central PEX 1/2" Pipe, 500'
- 1322 Central PEX 1/2" Pipe, 1000'

HeatLink® Manifold Actuators with LED

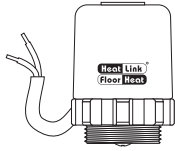

These actuators allow for additional room temperature control in conjunction with a room thermostat by mounting on a TwistSeal® supply manifold module (56200), Stainless Steel Manifold (56201), HeatLink® 62000 & 63000 series zone valves (56201), or TwistSeal® Multiport Manifold (56202). Includes a heat demand LED indicator.

- 56200 HeatLink Manifold Actuator w/LED
- 56201 HeatLink Valve Zone Drive Actuator w/LED
- 56202 HeatLink Multiport Manifold Actuator w/LED

HeatLink® Valve Actuator with LED

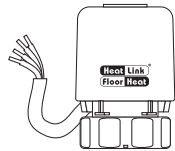

These motors allow for additional room temperature control in conjunction with a room thermostat by mounting on a TwistSeal® supply manifold module (56230), Stainless Steel Manifold (56231), HeatLink® 62000 & 63000 series zone valves (56231), or TwistSeal® Multiport Manifold (56232). Comes complete with end switch to allow pump and/or boiler switching.

- 56231 HeatLink Valve Actuator w/LED

Thermostatic Head with 6' Remote Capillary

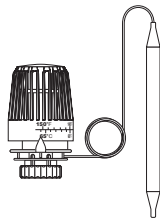

Used as injection control for HeatLink® zone valves. Senses 0.4°F (0.2°C) supply water change. Takes 15 minutes to close from full open.

Temperature adjustment range: 96-150°F (36-66°C).

- 57094 Thermostatic Head, 1"

Straight Zone Valve

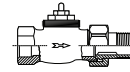

Provides on/off or modulated flow control for baseboard, fan coils, manifolds, injection controls, or miscellaneous supplemental heating units (e.g., towel warmers).

- 62025 Zone Valve, Straight 1"

Mixing Valve, 1" x 4-way FNPT

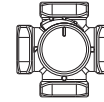

This unit mixes high-temperature boiler water with heating return water to create a supply water temperature. It has the option of manual operation, or it can be fitted with a Mixing Valve Motor for 1" to 2" FNPT Valves 3-Point Floating (#58131) or Mixing Valve Motor for 1" to 2" FNPT Valves DDC (#58132) for fully automatic operation.

- 64026 Mixing Valve, 1" x 4-way FNPT

PEX Connectors for TwistSeal Manifolds

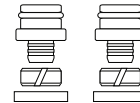

Solid brass fitting attaches to the end of the PEX tubing and allows for easy installation onto the bottom of the manifold module. Comes with O-ring.

- 77005 PEX Connector, 1/2" (pair)
- 77019 PEX Connector, 5/8" (pair)

TwistSeal® Mini Deluxe Supply/Return Module

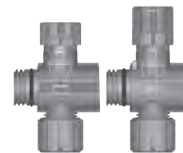

The supply module provides on/off manual control to allow isolation of individual loops. The return module permits balancing of the flow rate with flow setting dial. Comes with O-rings.

- 78200 TwistSeal Mini Deluxe Supply/Return Module

HeatLink Products

TwistSeal® Mini 2-Port Zone Valve Supply & Flow Meter Return Module Pair

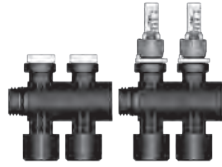

The supply module provides on/off manual control to allow isolation of individual loops. The return module permits visual balancing of the flow rate with the flow meter. Comes with O-rings.

78302 TwistSeal Mini 2-Port Module Pair

TwistSeal® Mini 3-Port Zone Valve Supply & Flow Meter Return Module Set

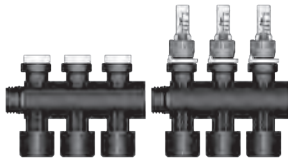

The supply module provides on/off manual control to allow isolation of individual loops. The return module permits visual balancing of the flow rate with the flow meter. Comes with O-rings.

78303 TwistSeal Mini 3-Port Module Pair

TwistSeal® Mini (40 mm) Manifold Assembly Kit

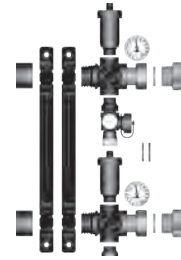

This package contains the items needed to assemble a mini deluxe heating manifold. Contents include:

- 2 mounting brackets
- 2 - 1" union cross tee end connection c/w green fiber gasket
- 2 - 1" MBSP × 1" FNPT adapter
- 2 red rubber gaskets for air testing
- 2 closed end caps
- 1 - 1/2" cross tee plug
- 1 thermometer pair
- 2 automatic air vents
- 1 hose bib
- 1 lubricant package

79200 TwistSeal Mini Manifold Assembly Kit

Aluminum Heat Transfer Plate



This plating is used to provide a direct transfer and heat distribution from the PEX piping to a wooden subfloor. They can be stapled to the underside of the subfloor in a DryBelow™ system or used above the subfloor in a DryAbove™ system.

End-to-end gaps between plates should be from 3" to 6" (75 to 150 mm). Plates measure 24" × 4-1/4" (610 mm × 108 mm).

87024 Aluminum Heat Transfer Plate, 24"

Adapters, PEX - Threaded Pipe

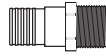

For adapting threaded pipe to Central PEX pipe.

- 1341 PEX Adapter, 1/2" PEX x 1/2" MIP fittings
- 1336 PEX Adapter, 1/2" PEX x 3/4" MIP fittings
- 1330 PEX Adapter, 1" PEX x 3/4" MIP fittings
- 1324 PEX Adapter, 1" PEX x 1" MIP fittings

Adapters, PEX - Copper Pipe



For adapting copper pipe to Central PEX pipe.

NOTE: The 1331 PEX Adapter can also be used for 3/4" sweat applications by sweating the fitting inside.

- 1337 PEX Adapter, 1/2" PEX x 1/2" sweat fitting
- 1331 PEX Adapter, 1" PEX x 3/4" or 1" sweat fitting
- 1348 PEX Adapter, 1/2" PEX x 1/2" FIP fitting
- 5000651 PEX Adapter, 1" PEX x 1" sweat fitting

Adapter, Brass PEX - Threaded Pipe



- 5000464 Brass PEX Adapter, 25mm x 3/4" NPT

Adapter, Female - Copper Pipe

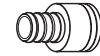

Adapts 1/2" copper pipe to 1/2" Central PEX pipe. Sweat end fits over copper pipe.

- 6679 Female Adapter, 1/2" barb x 1/2" sweat fittings

Adapters, PEX 90° Elbow



For coupling two Central PEX pipe ends together.

- 1340 PEX 90° Elbow, Brass, 1/2"
- 1334 PEX 90° Elbow, Brass, 1"

Adapter, Brass PEX 90° Elbow - Threaded Pipe



For coupling 1" Central PEX pipe to 3/4" MPT threaded pipe.

- 5000531 Brass PEX Adapter, 1" PEX x 3/4" MPT fittings, 90° Elbow

Tee, Brass - PEX



Brass tee for joining Central PEX pipe ends.

- 1338 PEX Tee, 1/2"
- 1332 PEX Tee, 1"

PEX Fittings - 1" PEX



- 1335 Crimp Ring, 1" PEX
- 5000557 Ball Valve, 1" PEX x 1" PEX, Full Port
- 0020-150 PEX Coupling, 1" FPT Swivel x 1" PEX
- 5000661 Ball Valve, 1" FIP

Fittings and Tools - PEX

Clamp Crimp Ring, PEX Stainless Steel



For use with Central PEX pipe. Install with Cinch Tool (p/n 5925) or Ratchet Cinch Tool (p/n 4472).

- 5000465 PEX Stainless Steel Clamp Crimp Ring, 25mm
- 5927 PEX Stainless Steel Clamp Crimp Ring, 1/2"
- 5926 PEX Stainless Steel Clamp Crimp Ring, 1"

Tools - PEX

0020-147



0020-146

- 0020-146 PEX Crimp Tool, 1"
- 0020-147 Crimp Tool, 3/8" x 1" Compact Combination

Cinch Tool

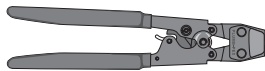

Tool for cinching 1" and 1/2" PEX Stainless Steel Clamp Crimp Rings to PEX pipe. Not for use with any other application.

- 5925 Cinch Tool

PEX Pipe Cutter

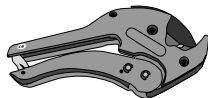

Designed for smooth, even cutting, the tool's jaw fits firmly over the pipe for a square, burr-free cut.

- 2900619 PEX Pipe Cutter

Ratchet Cinch Tool

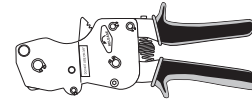

Compact, easy-to-use Ratchet Cinch Tool comes with calibrating device. For use with 5927, 5926 and 5000465 crimp rings.

- 4472 Ratchet Cinch Tool

Clamp Crimp Ring Removal Tool

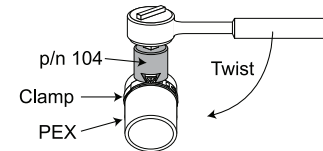

Used to remove PEX stainless steel clamp crimp rings (p/n 5927 and 5926).

- 104 Clamp Crimp Ring Removal Tool

PEX Hanger

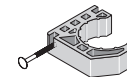

Half-moon, nail-in PEX Hanger for securing PEX piping. Available in two sizes.

- 293 PEX Hanger, 1/2"
- 295 PEX Hanger, 1"

Crimp Tool, Universal

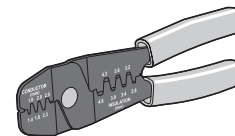

Used to crimp terminals. For 14-24 AWG wires.

- 2900341 Universal Crimp Tool, 14-24 AWG

Union, Brass Pipe - FIP



Suggested for use with plate-style heat exchanger installations.

5907	Brass Pipe Union, 3/4"
5908	Brass Pipe Union, 1"
5909	Brass Pipe Union, 1-1/4"
0020-184	Brass Union, 1-1/4" FPT

Coupler, Brass



0020-185	Brass Coupler, 1" FPT
0020-205	Brass Coupler, 1-1/4"
5367	Brass Coupling, 3/4" thread

Nipple, Brass

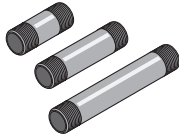

Brass nipples must be used on stainless steel furnaces.

535	Nipple, Brass, 3/4" x 2"
536	Nipple, Brass, 3/4" x 7"
5000394	Nipple, Brass, 3/4" x 4"
0020-186	Brass Nipple, 1" Short

Tee, Brass



0020-187	Brass Tee, 1" FPT
----------	-------------------

Tee, Brass, 3/4"

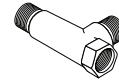

Brass Tee, 3/4" male x female x male. Mainly used for installing heat exchanger on water heater when push-fit fittings are used.

9624	Tee, Brass, 3/4"
------	------------------

Tee, Brass Offset, 4"

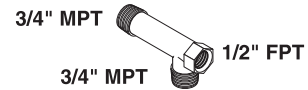

Can be used in conjunction with the Temperature Gauge (p/n 174 or p/n 6054) for monitoring furnace supply water temperature, or may be used instead of Nipple (p/n 533) and 90° Street Elbow (p/n 274) on supply and/or return bung.

6764	Brass Offset Tee, 4"
------	----------------------

Reducer Bushing, Brass



0020-188	Brass Reducer Bushing, 1" x 1/2"
0020-189	Brass Reducer Bushing, 1-1/4" x 1"
0020-192	Brass Reducer Bushing, 3/4" to 1"
0020-204	Brass Reducer Bushing, 1-1/2" x 1"
385	Brass Hex Bushing, 1-1/2" x 3/4"
3851	Brass Hex Bushing, 1-1/4" x 3/4"
3042	Brass Hex Bushing, 1/2" x 1/8"

Elbow, Brass



0020-190	Brass Street 90° Elbow, 1"
0020-194	Brass 90° Elbow, 1" FPT

Adapter, Brass



0020-195	Brass Adapter, 1/2" MIP x 3/4" FPT Hose Bib
----------	---

Fittings - Threaded

Adapter, Female, 3/4" Hose, Brass



4928 Brass Adapter, 3/4" female hose x 3/4" male pipe

Adapter, Male, 3/4" Hose, Brass



4929 Brass Adapter, 3/4" male hose x 3/4" male pipe

Nipple, Black



0020-250 Nipple, Black, 1" x 2"
 0020-251 1" x 3" Black Nipple
 0020-252 Nipple, Short Black, 3/8" x 1-1/2"

Nipple, Close - Black



Nipple (p/n 118) is used with pumps and ball valves. All nipples listed here are Schedule 80, extra heavy.

118 Nipple, 3/4" x close, Schedule 80, extra heavy
 409 Nipple, 1-1/4" x close, Schedule 80, extra heavy
 314 Nipple, 1-1/2" x close, Schedule 80, extra heavy

Tee, Black

0020-255 Tee, Black, 1"

Reducer Bushing, Black



0020-257 Reducer Bushing, Black, 3/4" x 1"
 0020-258 Reducer Bushing, Black 1-1/2" x 1"
 0020-259 Reducer Bushing, Black, 3/8" x 1/2"
 0020-260 Reducer Bushing, Black, 1" x 1/2"

Bushing, Hex - NPT



Hex bushing with national pipe threads (NPT).

180 Hex Bushing, 3/4" x 1/8"
 408 Hex Bushing, 1-1/2" x 1-1/4"

Tees, NPT



Black Tee (p/n 133) can be used for vent option near pump. Brass Tee (p/n 3850) can be used in domestic water situations. Black Tee (p/n 418) can be used to install 1-1/4" thermostatic valve.

133 Tee, Black, 3/4" NPT
 3850 Tee, Brass, 3/4" NPT
 418 Tee, Black, 1-1/4" NPT

Elbow, 45° Street



NPT 45° Street Elbow (black).

124 45° Street Elbow, 3/4"
 5000017 45° Street Elbow, 1-1/4"

Elbow, 90° Street



90° Street Elbow in different sizes.

- 411 90° Street Elbow, 1-1/4"
- 274 90° Street Elbow, 3/4"
- 126 90° Street Elbow, Brass, 3/4"

Elbow, 90° - FPT



90° Elbow with female threads.

- 956 90° Elbow, 3/4" x 3/4" FPT
- 5000016 90° Elbow, Black, 1-1/4"

Caps, Round Pipe



- 332 3/4" Round Pipe Cap
- 333 1-1/4" Round Pipe Cap

Plug, Pipe - MPT



Pipe Plug, MPT, black, unless noted.

- 331 Pipe Plug, 3/4"
- 574 Pipe Plug, Brass 3/4"
- 336 Pipe Plug, 1-1/2"
- 383 Pipe Plug, 1-1/4"
- 6557 Pipe Plug, Brass 1/2"

Plug, Pipe - Wrench Set

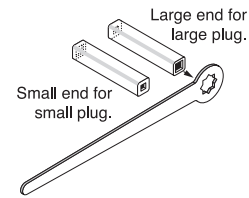

Large end is for 1-1/4"; small end fits 3/4" pipe plugs.

- 5459 Pipe Plug Wrench Set

Gauges, Temperature

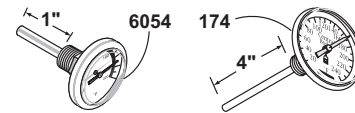

In-line, dial temperature gauge with 1/2" MPT (p/n 174) is optional for manifold, pool heater systems, etc. Gauge (p/n 6054) is 1/8" MPT, 1" diameter with 1" stem length, for use in tight areas.

- 6054 Temp. Gauge, 1/8" MPT
- 174 Temp. Gauge, 1/2" MPT

Fittings - Sharkbite

Sharkbite Fittings

Reducer Coupling



MPT Adapter



Elbow



Tee



Coupling



Female Adapter

Sharkbite Fittings - Coupling, Straight

- 0020-501 Sharkbite Coupling, 3/4"
- 0020-502 Sharkbite Coupling, 1"

Sharkbite Fitting - Coupling, Reducing

- 0020-503 Sharkbite Reducer Coupling, 3/4" x 1/2"
- 0020-530 Sharkbite Coupling, Reducing, 1/2" x 3/4" MNPT
- 0020-531 Sharkbite Coupling, Reducing, 1" x 3/4" MNPT
- 0020-532 Sharkbite 90° Elbow, Reducing, 3/4" x 1/2"

Sharkbite Fitting - Female Adapter

- 0020-505 Sharkbite Adapter, 1/2" Female
- 0020-506 Sharkbite Adapter, 3/4" Female
- 0020-507 Sharkbite Adapter, 1" Female

Sharkbite Fitting - Adapter, Male

- 0020-509 Sharkbite Adapter, 3/4" MPT
- 0020-510 Sharkbite Adapter, 1" MPT

Sharkbite Fittings, Elbow

- 0020-511 Sharkbite Elbow, 1/2"
- 0020-512 Sharkbite Elbow, 3/4"
- 0020-513 Sharkbite Elbow, 1"

Sharkbite Fitting, Tee

- 0020-515 Sharkbite Tee, 1/2"
- 0020-517 Sharkbite Tee, 1"

Sharkbite Ball Valve

- 0020-544 Sharkbite Ball Valve, 1"

Push-fit Fittings - Coupling, Straight

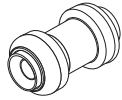

- 606 Push-fit Coupling, Straight, 1/2" x 1/2"
- 607 Push-fit Coupling, Straight, 3/4" x 3/4"
- 608 Push-fit Coupling, Straight, 1" x 1"

Push-fit Fitting - Coupling, Reducing

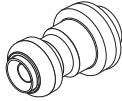

- 609 Push-fit Coupling, Reducing, 1" x 3/4"

Push-fit Fitting - Female Adapter



- 611 Push-fit Female Adapter, 1" x 1" FPT

Push-fit Fitting - Adapter, Male

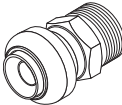

- 612 Push-fit Male Adapter, 1" x 3/4" MPT

Push-fit Fitting - Connector, Straight



- 9264 Push-fit Connector, Straight, 3/4" x 3/4" MIP

Push-fit Fittings, Elbow

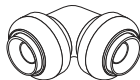

- 613 Push-fit Elbow, 1" x 1"
- 9265 Push-fit Elbow, 3/4" x 3/4"

Push-fit Fitting, Tee



- 614 Push-fit Tee, 1" x 1" x 1"

Push-fit Fitting - Temperature Gauge



1/8" MPT Temperature Gauge (p/n 6054) installs on Temperature Gauge Fitting and fitting installs on push-fit fitting Tee (p/n 614).

- 1350 Push-fit Temperature Gauge Fitting, 1" x 1/8" NPT

Push-fit - Depth Gauge/Deburring Tool

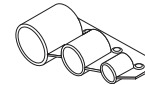

Deburs pipe and used to mark pipe to indicate when the pipe is inserted completely into the fitting. One tool for 1/2", 3/4" and 1" pipe.

- 615 Push-fit Depth Gauge/Deburring Tool

Push-fit - Disconnect Clip



Used to disconnect push-fit fittings quickly and easily.

- 616 Push-fit Disconnect Clip, 1/2"
- 617 Push-fit Disconnect Clip, 3/4"
- 618 Push-fit Disconnect Clip, 1"

Push-fit - Disconnect Tongs



0020-534
0020-535
0020-536

- 0020-534 Push-fit Disconnect Tongs, 1/2"
- 0020-535 Push-fit Disconnect Tongs, 3/4"
- 0020-536 Push-fit Disconnect Tongs, 1"

Fittings - Copper/Sweat

Cap, Copper End



376 Copper End Cap, 1" sweat fitting

Elbow, Vent - Copper



372 Vent Elbow, 3/4" x 3/4" sweat fittings
112 Vent Elbow, 1" x 1" sweat fittings

Reducer, Copper



231 Reducer, Copper Pipe, 1" x 3/4" sweat fittings
0020-228 Reducer, Copper, 3/4" x 1" sweat fitting

Elbow, 90° Reducing - Copper



123 90° Reducing Elbow, 1" x 3/4" sweat fittings
0020-220 90° Reducing Elbow, 3/4" x 1" sweat fitting

Elbow, 90° - Copper



276 90° Elbow, 3/4" x 3/4" sweat fittings
0020-221 90° Elbow, 3/4" sweat fittings
277 90° Elbow, 1" x 1" sweat fittings
0020-222 90° Elbow, 1" sweat fittings

Tee, Brass Diverter

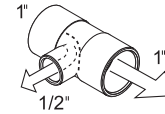

The diverter tee is an excellent sweat fitting used mainly with fan-forced heaters.

6782 Brass Diverter Tee, 1" x 1" x 1/2" sweat

Elbow, 90° Street - Copper



90° street elbow with 1" female sweat fitting on one end and 1" male sweat fitting on the other.

103 Street Elbow, 1"
0020-224 90° Street Elbow, 1" sweat fitting

Couplings, Copper



146 Copper Coupling, 3/4" sweat x 3/4" sweat fittings
147 Copper Coupling, 1" sweat x 1" sweat fittings

Adapters, Male - Copper



116 Male Adapter, 3/4" sweat x 3/4" MIP fittings
120 Male Adapter, 1" sweat x 1" MPT fittings
0020-225 Coupling, 3/4" MPT x 3/4" female sweat fitting
0020-226 Coupling, 3/4" MPT x 1" female sweat fitting
0020-227 Coupling, 1" MPT x 1" female sweat fitting
0020-233 Coupling, 1" male sweat x 1" FPT fitting

Adapters, Female - Copper



- 164 Female Adapter, 1" sweat x 3/4" FIP fittings
- 117 Female Adapter, 3/4" sweat x 3/4" FIP fittings

Tees, Copper

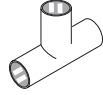

- 138 Tee, Copper Pipe, 1" x 1" x 1" sweat fittings
- 255 Tee, Copper, 3/4" sweat fitting
- 0020-230 Tee, 1" sweat fitting

Tee, Reducing - Copper



- 178 Reducing Tee, 1-1/2" x 1" x 1" sweat fittings
- 0020-231 Copper Tee, 2" x 1" x 1"

Solder & Soldering Flux



Low melting-point solder for easier soldering. Soldering flux includes brush. Use for easier soldering of copper sweat fittings.

- 1325 Solder
- 100 Soldering Flux (6 oz)

Brush, Cleaning



For cleaning the inside of copper fittings.

- 378 Cleaning Brush, 3/4"
- 379 Cleaning Brush, 1"

Aquastats / Thermostats

Aquastats & Thermostats

0020-376



0020-377



0020-376 Electronic Aquastat with 8' wire and 1/4" probe
 0020-377 Strap-On Aquastat (2E859)

Fan Center Relay

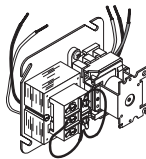

The Fan Center Relay is used to control a 110-volt fan with a 24-volt thermostat.

515 Fan Center Relay

0020-380



0020-382



0020-380 Low-Volt Thermostat, 24V
 0020-382 Circuit Transformer

Thermostat, Line Voltage

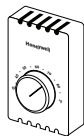

Line Voltage Thermostat (120-volt) used to start the fan on forced-air systems.

1267 Line Voltage Thermostat

Relay, 24-Volt

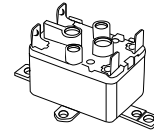

Used to connect a 24-volt thermostat to existing thermostat for a heat pump.

8200293 Power Relay, 24V, SPNO-SPNC

Thermostat, Plug-in

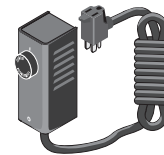

Plug-in Thermostat, 13.5-amp rated, 110-Volt, is for operating fan.

368 Plug-in Thermostat

Transformer, 24-Volt

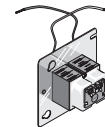

Used with 24-volt wall thermostat and 24-volt zone valves.

188 24-Volt Transformer

Vent Valve, Automatic

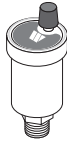

Vents air automatically. For use in pressurized systems only. Fitting is 1/8" NPT.

286 Automatic Vent Valve

Check Valves

0020-403



0020-402



0020-402 Check Valve, 1"
0020-403 Brass Swing Check Valve, 1" FPT

Check Valve, Swing - Brass



Brass Swing Check Valve with FIP fittings prevents reverse circulation.

296 Brass Swing Check Valve, 3/4"
5871 Brass Swing Check Valve, 1-1/4"

Tempering Valve, Sweat



Tempering Valve has temperature range of 110°F - 170°F.

0020-408 Tempering Valve, 3/4" Sweat

Radiant Mixing Valve, Sweat



0020-410 Radiant Mixing Valve, 1" Sweat
0020-411 Radiant Mixing Valve, 3/4" Sweat

3-Way Zone Valve, Sweat



0020-412 3-Way Zone Valve, 1" Sweat

Zone Valves, Zone Sentry®

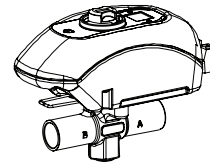

On-off, normally open or normally closed control in open and closed hydronic systems. Simple to install and operate, the valve can be installed in any direction, in any orientation. Snap-in quick connects make for a simple and secure wiring hook-up. LED shows full functionality of the valve's operation and thermostat status. Uses half the power of the 560 Series Zone Valves. 2-way or 3-way zone valves available.

5800021 3-Way Zone Sentry Zone Valve, 3/4" NPT threads
5800030 3-Way Zone Sentry Zone Valve, 3/4" sweat
5800028 3-Way Zone Sentry Zone Valve, 1" sweat
5800020 2-Way Zone Sentry Zone Valve, 3/4" NPT threads
5800027 2-Way Zone Sentry Zone Valve, 1" sweat
5800022 Replacement Actuator Head for 5800020 and 5800021

Valves

Ball Valve, Sweat

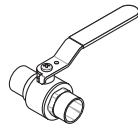

200 Sweat Ball Valve, 3/4" x 3/4" sweat fitting - Lead Free

Ball Valve, PEX



Full port ball valve for Central PEX.

5000556 Ball Valve, 1/2" PEX, Full Port
 5000557 Ball Valve, 1" PEX, Full Port

Ball Valve

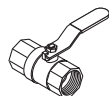

Brass FIP Ball Valves. The 3/4" Full Port Ball Valve (p/n 198) is used on both sides of the pump and on the furnace for each water line.

186 Ball Valve, 1/2"
 198 Ball Valve, 3/4" Full Port - Lead Free

Hose Bibs, Brass



Brass hose bib, 3/4" MPT. Use brass cap (p/n 5348) with washer (p/n 5349) to cover end.

199 Brass Hose Bib, 3/4" MPT
 5349 Washer, 3/4"
 5348 Cap, Brass, 3/4"

Valve, Tempering

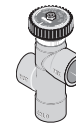

Mixing valve for tempering hot water, with an adjustable temperature range between 120-160°F.

140 Tempering Valve, 3/4" sweat fittings

Valve, Radiant Mixing

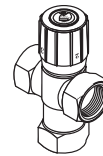

For controlling water temperature in various types of radiant heat systems. Temperature range 70°F - 145°F. Not an anti-scald valve and not intended to be used on water heaters.

306 Radiant Mixing Valve, 1/2" NPT fittings
 327 Radiant Mixing Valve, 3/4" NPT fittings
 329 Radiant Mixing Valve, 1" NPT fittings

Valve, Water Heater Mixing

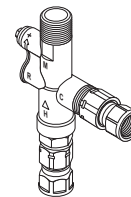

Designed specifically for water heaters, with a temperature range of 90°F - 130°F.

5000392 Water Heater Mixing Valve, 3/4" NPT fittings, lead free

SuperPro Chimneys (Selkirk)

Selkirk SuperPro chimneys offer the latest technology in factory-built chimney design-providing superior performance, durability and safety.

Features:

- Superior Performance • Premium Grade Stainless Steel
- 1" Solid Pack Insulation • Certified to UL 103 HT for all fuel use

NOTE: SuperPro Chimneys fit furnaces manufactured after August 11, 2009.

SuperPro Chimneys - 6" Diameter

- 1709-060 6" Chimney Cap
- 1709-061 6" Cover Cap
- 1709-062 6" Chimney Male Coupler
- 1709-063 Chimney Spark Arrestor Mesh, 6"
- 1709-064 6" x 24" SuperPro SS Chimney
- 1709-065 6" x 48" SuperPro SS Chimney
- 1709-067 6" Chimney Tee w/Plug
- 1709-068 6" x 30° Chimney Elbow Kit
Includes: 30° Chimney Elbow (2 ea.), Chimney Locking Band (4 ea.), Chimney Elbow Support
- 1709-069 6" Chimney Locking Band

SuperPro Chimneys - 8" Diameter

- 1709-080 8" Chimney Cap
- 1709-081 8" Cover Cap
- 1709-082 8" Male Coupler
- 1709-083 Chimney Spark Arrestor Mesh, 8"
- 1709-084 8" x 24" SuperPro SS Chimney
- 1709-085 8" x 48" SuperPro SS Chimney
- 1709-086 8" x 30° Chimney Elbow Kit
Includes: 30° Elbow (2 ea.), Chimney Locking Band (4 ea.), Chimney Elbow Support
- 1709-087 8" Chimney Tee w/Plug
- 1709-089 8" Chimney Locking Band

Chimney Band Clamp Kit, 8"

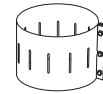

Reinforces strength between two sections of 8" chimney.

- 4518 Chimney Band Clamp Kit, 8"

Chimney Base Brace Kit, 8"

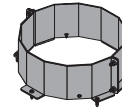

Used to reinforce the chimney base when three or more chimney sections are used.

- 4519 Chimney Base Brace Kit, 8"

Clamp, Snaplock Chimney - 8"

- 10509 Clamp, Snaplock Chimney - 8"

Chimney Guy-Wire Band Kit, 8"



Used to provide additional stability to chimneys in installations where property damage could occur within the fall zone of the chimney. Guy wire is not included in kit.

- 778 Chimney Guy-Wire Band Kit

Chimney Cap/Spark Arrestor

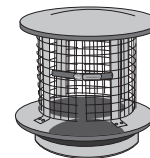

New version chimney cap/spark arrestor provides better fit, features a snaplock clamp and screen that is secured with a clamp-on fastener for easy removal. Available for 6" and 8" chimneys. Compatible with Security chimneys.

- 2900597 6" Chimney Cap/Spark Arrestor
- 2900598 8" Chimney Cap/Spark Arrestor

Chimney

Twist-Lock Chimneys (Security)

NOTE: Twist-Lock Chimneys fit furnaces manufactured before August 11, 2009.

6500004	6" x 48" Twist-Lock Stainless Steel Chimney
10508	8" x 48" Twist-Lock Stainless Steel Chimney
0709-100	10" Twist-Lock Chimney Cap
0709-102	10" Twist-Lock Male Coupler
0709-104	10" x 24" Twist-Lock Stainless Steel Chimney
0709-105	10" x 48" Twist-Lock Stainless Steel Chimney
0709-130	Twist-Lock Spark Arrestor Mesh

Draft Inducer Kits

0109-734 Draft Inducer, LT 90 and AFS models

MolyArmor 350 Corrosion Inhibitor



MolyArmor 350 Corrosion Inhibitor (boiler treatment) provides excellent water jacket corrosion protection when properly maintained at a minimum of 350 ppm. It is easy to test for maintenance levels with a test kit (p/n 2500598). One gallon of MolyArmor 350 Corrosion Inhibitor treats 200 gallons of system water.

Models	Initial MolyArmor 350 Amount
Maxim M255 PE; 3300	1/2 unit
CleanFire 300, 500; 4400, 5500	1 unit
CleanFire 700	2 units
6500	2-1/2 units
2900631 MolyArmor 350 Corrosion Inhibitor, 1 gal.	

Moly/pH Test Kit



Test Kit and replacement items for testing your furnace water ONLY if treated with MolyArmor 350 Corrosion Inhibitor. Complete kit includes moly test strips and litmus paper test strips.

2500598	Moly/pH Test Kit, Complete
2900632	Moly Test Strips, qty. 25
153	Litmus Paper

Antifreeze



0020-425

0020-425	Antifreeze, Non-Toxic Boiler, 1 gal.
0020-426	Antifreeze, Non-Toxic Boiler, 5 gal
0020-427	Antifreeze, Non-Toxic Boiler, 55 gal.

Sludge Conditioner



Reduces mineral deposits in boiler side of water-to-water heat exchangers. Can be used as a preventative when filling the furnace or as a rescue treatment if corrosion occurs in the water jacket due to improperly maintained Corrosion Inhibitor levels.

Refer to following chart for the amount to use for each model furnace for preventative or rescue treatment applications. Note that 1 unit = 1 gallon.

PREVENTATIVE IN HARD WATER: While it is best to use softened water when filling the furnace, Sludge Conditioner should be used if the water quality is known to contain higher concentrations of minerals or solids.

RESCUE TREATMENT FOR CORROSION: If a furnace has been subjected to low Corrosion Inhibitor levels and corrosion is evident in the water jacket, Sludge Conditioner can be used by circulating through the furnace for one week to help clean some of the corrosion from inside the water jacket before flushing and refilling.

Models	Preventative Amount	Rescue Amount
Maxim M255 PE; 3300, 4400		
CleanFire 300	1/2 unit	1 units
CleanFire 500, 700; 5500	1 unit	2 units
6500	2 units	4 units
166 Sludge Conditioner, 1 gal.		

Cleaner

0020-438	Multi-Purpose Stove and Soot Cleaner
----------	--------------------------------------

Furnace Replacement Parts

Replacement Fan

- 0109-730 Replacement Fan (4C012) - 3300, old 434
- 0109-731 Replacement Fan (4C004) - 3300, 434, 5500 (rear), AFS 900 and LT90



0109-732

- 0109-732 Replacement Fan (4C446) - 4400, 5500, 546, 6500, 658 & AFS1100



0109-790

- 0109-790 Solenoid, Laminated
- 0209-500 Draft Spring
- 0109-101 Snap Disc

Replacement Fan Cover



0709-051

- 0709-051 Fan Cover, WoodMaster Models and LT 90

Firebox Door



3300 Firebox Door

- 2700282 Firebox Door, 3300/434
- 2700283 Firebox Door, 4400/546
- 2700284 Firebox Door, 5500
- 7992-657 Firebox Door, 6500, LH
- 7992-658 Firebox Door, 6500, RH
- 7992-110 Firebox Door Assembly, AFS900/1100/LT90

Replacement Silicone



- 806 Black Silicone Adhesive, High Temperature, 10.1 oz

Replacement Door Rope



- 7594 Door Rope, 1" Fiberglass, Firebox - Per Foot (250' per box)

ETC Assembly, Wood Stove



- 7992-901 ETC Panel Assembly, Wood Stove

Dixell Temp Control



- 0109-001 Dixell Temp Control
- 0409-027 ETC Gasket
- 0109-152 Fan Switch, ON/OFF
- 0109-045 Dixell Face Plate
- 0409-003 ETC Back Box
- 430-0021 ETC Cover UV Shield
- 0219-021 Lock Nut, Center, 5/16"-18 (requires 4 per panel)

Replacement Harnesses

- 0109-401 ETC Wire Harness, Wood Stoves
- 0109-411 Stove Harness, Single Blower - 3300/4400
- 0109-412 Stove Harness, Double Blower - 5500
- 0109-413 Stove Harness - 6500

Replacement Night Light Glass Cover



0020-777

- 0020-777 Glass Cover, Night Light

Replacement Water Level Light



0109-245

- 0109-245 Water Level Light Receptacle, Green LED



0109-100

- 0109-100 Float Assembly, Water Level Light



0109-153

- 0109-153 Switch, Light On/Off

Replacement Thermistor



0109-002

- 0109-002 Thermistor, Digital Aquastat
- 0109-009 Thermistor, Digital Aquastat, AFS 900

Replacement Thermowell



0109-003

- 0109-003 Thermowell, 1/2"

Replacement Temperature Probe

- 0109-620 Temperature Probe, LT 90 RTD

Replacement Water Pressure Switch



Water Pressure
Switch

- 0109-191 Water Pressure Switch, 4"
- 0109-192 Water Pressure Switch, 1-1/4"

Replacement On/Off Switch

- 0109-152 Switch, Fan On/Off

Furnace Replacement Parts

Slide Rod Plates

Slide Rod Plate

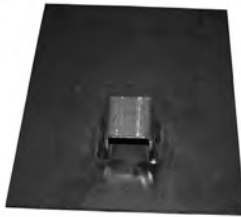

- 0809-334 Slide Rod Plate, 3300
- 0809-444 Slide Rod Plate, 4400
- 0809-554 Slide Rod Plate, 5500
- 0809-654 Slide Rod Plate, 6500

Slide Rod/Assemblies

- 7992-033 Breakaway Slide Rod Assembly, 3300



440 Breakaway Slide Rod

- 7992-044 Breakaway Slide Rod Assembly, 4400
- 7992-055 Breakaway Slide Rod Assembly, 5500
- 7992-332 Slide Rod Assembly, 3300
- 7992-442 Slide Rod Assembly, 4400
- 7992-552 Slide Rod Assembly, 5500
- 7992-652 Slide Rod Assembly, 6500
- 0909-653 Slide Rod, 6500

Ash Removal Systems

Triple Auger Assembly



- 7992-444 Ash/Auger Kit, 4400
- 0809-400 Ash Grate, 4400
- 0809-404 Triple Auger Assembly, 4400
- 0809-403 Triple Ash Auger WMT, Inside (Center Auger), 4400
- 7992-554 Ash/Auger Kit, 5500
- 0809-500 Ash Grate, 5500
- 0809-504 Triple Auger Assembly, 5500
- 0809-503 Triple Ash Auger WMT, Inside (Center Auger), 5500
- 7992-328 Auger Tube Cover w/Ash Drop Out Door
- 0909-401 Crank Handle, Ash Auger (fits all models)

Auger Chains



- 0020-800 Auger Chain, 4400
- 0020-801 Auger Chain, 5500

Replacement Vent Cap

7992-021



- 7992-021 Vent Cap

AFS Replacement Parts - Fire Pot



0809-012

0809-012 Fire Pot, AFS 900



0609-023

0609-023 Fire Pot Front Plate, AFS 900
7995-013 Fire Pot With End Plate, AFS 1100



0611-022

0611-022 Front Plate, AFS 1100

AFS Replacement Parts - Augers



0609-500

0609-500 High Temperature Auger, AFS 900

0611-513



0611-512

0611-512 High Temperature Auger, LH, AFS 1100
0611-513 High Temperature Auger, RH, AFS 1100

AFS Replacement Parts - Motor Items



0109-701

0109-701 Motor, AFS 900

AFS Replacement Parts



0109-702

0109-702 Motor, AFS 1100

AFS Replacement Parts



0109-010

0109-010 Thermocouple, AFS 900



0109-194

0109-194 Air Pressure Switch, AFS 900



7992-795

7992-795 Actuator, AFS 900



0109-601

0109-601 Ignitor, AFS 900 (800 Watt)



0209-252

0209-252 Morris Coupling
0209-254 Morris Coupling Gasket Seal



0699-118

0699-118 Return Line Pipe, AFS 1100

Flex Fuel Replacement Parts

Flex Fuel Replacement Parts - Handles



041-0028

041-0028 Door Handle



0409-013

0409-013 Firebox Handle

050-1085 Door Handle, LH

Flex Fuel Replacement Parts - Door Hinge

050-0027 Door Hinge

Flex Fuel Replacement Parts - Door Rope

071-3001 Door Rope Seal, Top Door, 30kW

071-3002 Door Rope, Top Door, 30k

071-3003 Door Rope, Ash Door, 30k

071-6001 Door Rope Seal, Ash Door, 60kW

071-6002 Door Rope, Top Door, 60k

071-6003 Door Rope, Top Door, 60kW

Flex Fuel Replacement Parts - Firebox Door Latch

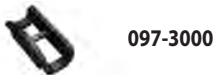

097-3000

097-3000 Firebox Door Latch

Flex Fuel Replacement Parts - Heat Exchanger Motor



0109-710

0109-710 Heat Exchanger Motor

Flex Fuel Replacement Parts - Heat Exchanger Gaskets



Heat Exchanger Gasket

041-3022 Heat Exchanger Gasket, 30 kW

041-0006 Heat Exchanger Gasket, 60 kW

Flex Fuel Replacement Parts - Heat Exchanger Motor Bearing



050-0008

050-0008 Bearing, Heat Exchanger Motor

Flex Fuel Replacement Parts - Primary Air Plates

Primary Air Plate



251-2390 Primary Air Plate, 30 kW

251-5090 Primary Air Plate, 60 kW

Flex Fuel Replacement Parts - Grates



Wood Grate Insert

351-8540 Wood Grate Insert, 30 kW

351-6800 Wood Grate Insert, 60 kW

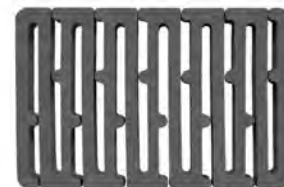

Pellet Grate Insert

351-7000 Pellet Grate Insert, 30 kW

351-6990 Pellet Grate Insert, 60 kW

Flex Fuel Replacement Parts - Funnels



Funnel

551-3005 Funnel, 30 kW

551-6005 Funnel, 60 kW

Flex Fuel Replacement Parts

Flex Fuel Replacement Parts - Ash Tools



0209-400

0209-400 Ash Scoop Handles

Flex Fuel Replacement Parts - Leveling Foot



021-0056

021-0056 Leveling Foot

Flex Fuel Replacement - Draft Fan and Capacitor



0109-739

0109-739 Draft Fan and Capacitor

Flex Fuel Replacement Parts - Display Mounting Hardware



021-8322
021-0501

021-0501 Mounting Hardware, Display
021-8322 Mounting Hardware, Display

Flex Fuel Replacement Parts - Servomotor



011-0002

011-0002 Servomotor

Flex Fuel Replacement Parts - Control Panel Displays

011-0013 30 kW Control Panel Display
011-0016 60 kW Control Panel Display



011-0006

Flex Fuel Replacement Parts - I/O Board

011-0006 I/O Board

Flex Fuel Replacement Parts - Snap Disc



011-0036

011-0036 Snap Disc

Flex Fuel Replacement Parts - Display Knob



011-0039

011-0039 Display Knob

Flex Fuel Replacement Parts - Solenoid

011-0060 Solenoid

Flex Fuel Replacement Parts - Buffer Temperature Probe



011-6004

011-6004 Buffer Temperature Probe

Renovator Replacement Parts

Renovator Replacement Parts - Compressor

- 100-0017 Air Compressor
- 430-0015 Hose, Air Compressor

Renovator Replacement Parts - Auger

- 800-0011 Auger Spiral



- 800-0122 Auger T-Pipe



- 610-0370 Auger Intake Pipe
- 430-0011 Auger Pipe



- 700-0078 Auger Feed Motor Assembly, Renovator 20
- 130-0001 Auger Motor, Feed, 5.3 RPM
- 610-0369 Auger Feed Hose Adapter, Renovator 20

Renovator Replacement Parts - Hopper Boot

- 0409-212 Boot, Steel/Plastic Hopper

Renovator Replacement Parts - Burn Pot



Renovator 20
Burn Pot

- 800-0116 Burn Pot, Renovator 20
- 800-0133 Burn Pot, Renovator 30
- 610-0367 Flame Guard

Renovator Replacement Electronics



- 100-0035 Snap Disc, Renovator 20
- 100-0038 Fuse, 3.15A
- 100-0048 Relay, Renovator
- 100-0043 Temperature Control, Renovator
- 160-0000 Ignitor, 400W
- 100-0037 Photosensor

Renovator Replacement Parts - Combustion Fan



430-0008

- 430-0008 Hose, Blue Intake
- 120-0003 Combustion Fan, Renovator

Renovator Replacement Parts - Shroud

- 430-0007 Shroud, Renovator

CleanFire Kit for Delivery Trailer

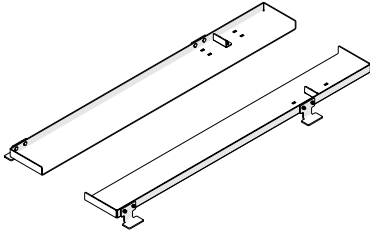

Kit adapts the delivery trailer for transporting CleanFire models with a skidbase. Must be removed for hauling a furnace with legs.

2500595 CleanFire Kit for Delivery Trailer

Sediment Trapper Filter, Hot Water, 3/4"

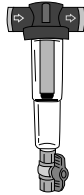

Centrifugal separation technology and 100 mesh filter element. Amber see-through cover easily removable for cleaning using no tools. Bottom valve used to empty sediment. Stainless steel screen filter is cleanable and reusable.

Rated to 200°F (93°C) @ 40 psi. Dimensions: 14-3/8"L x 5"W. Port size: 3/4" FPT.

2900578 Hot Water Sediment Trapper Filter, 3/4" FPT
 5000683 O-Ring, Replacement, for Hot Water Filter (p/n 2900578)

Multimeter, Digital Pocket



Digital multimeter performs several electrical measurement functions in one simple-to-use instrument.

2657 Digital Pocket Multimeter

Hoe, Firebox

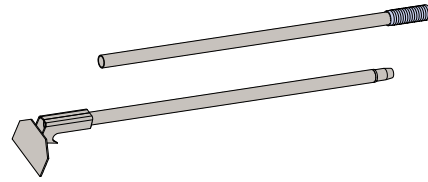

Used as a firebox maintenance tool; hoe includes metal handle.

2900001 Hoe, Firebox, 72"

Hoe, Ash

For use in all wood stoves.

7992-329 Ash Hoe

Brush, Stainless Steel

0020-772 Stainless Steel Brush, 2" x 36" for tube cleaning

Torch, Outdoor

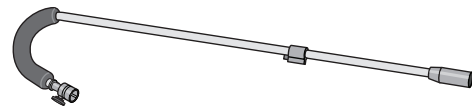

Torch design allows easy starting of the fire in CleanFire and Maxim models.

2900325 Outdoor Torch

24V Fan Conversion Kit

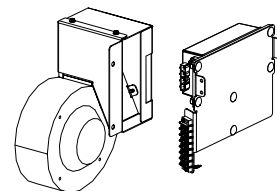

Kit is used to allow a CleanFire furnace to be operated with 24V DC (for systems off the grid, for example). Includes a 24V Combustion Fan and a low-voltage replacement power supply. Only for CleanFire 300, 500 or 700 (will not work for CleanFire 900).

2500633 24V Fan Conversion Kit

CleanFire Furnace Parts & Accessories

Pump Panel Extension Kit - CleanFire 300/500

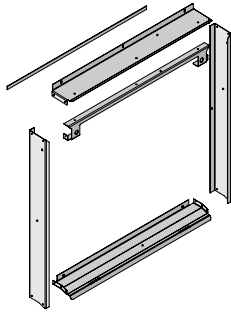

Kit provides additional room for mounting more than one pump on CleanFire 300 or 500 models.

2500164 Pump Panel Extension Kit

Switch, Bypass Alarm

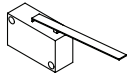

Replacement Bypass Alarm Switch for CleanFire 500 or 700 furnaces.

8200044 Switch - Bypass Alarm

Combustion Fan Assembly

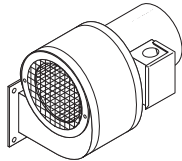

Replacement Combustion Fan with connectors for CleanFire models.

2000737 Combustion Fan

Switch, Door - CleanFire



Replacement Door Switch for CleanFire furnaces.

8932 Door Switch

Switch, Rocker



Power Supply Rocker Switch is for CleanFire models with 5A breaker.

11220 Rocker Switch, Power Supply (on-off), 5A breaker

Snap Disc - CleanFire



Replacement snap disc for CleanFire models.

8200000 Snap Disc, 180-205°F, (High Limit Water Jacket)

Motor, Stepper - Assembly

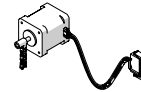

Replacement stepper motor for CleanFire models. Includes chains and wiring harness.

2001241 Stepper Motor Assembly

Lens and Light Bulb

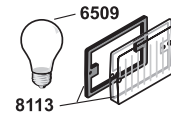

Replacement Lens w/Gasket and Light Bulb.

8113 Lens w/Gasket

6509 Light Bulb, 40 W

Thermocouple Kit, Universal

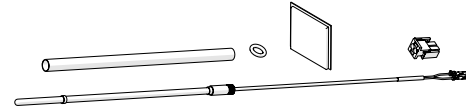

Kit includes components for installing Reaction Chamber thermocouple on all CleanFire models. Not all components are used for every installation.

2500582 Thermocouple Kit, Universal - CleanFire models

Switch, Float - Water Level

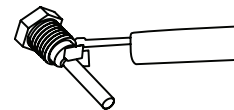

Replacement stainless steel water level float switch for CleanFire models.

2500467 Water Level Float Switch, Stainless Steel

CleanFire Furnace Parts & Accessories

Sensor Kit, Water Temperature - CleanFire



Replacement water temperature sensor kit for CleanFire models. Includes sensor and wire lead, mastic tape and instructions.

727 Water Temperature Sensor Kit, CleanFire models
5958 Temperature Sensor Well

Controller, FireStar - CleanFire



Replacement controller for CleanFire models. Note that the Power Supply (p/n 8200275) is sold separately.

2001269-SPFireStar Controller for CleanFire

Power Supply

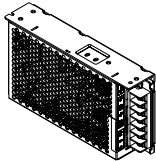

Replacement power supply for FireStar combustion controller on CleanFire models.

8200275 Power Supply, Stepper Motor

Bushing/Collar, Door Latch - Kit

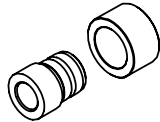

Replacement bushing and spacer for CleanFire door latch.

2500195 Door Latch Bushing Kit

Door Seal

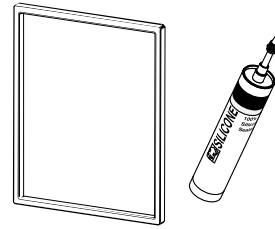

Kits include Door Seal and Bronze Silicone Adhesive for CleanFire model doors. Door seals are pre-formed to fit properly.

2500177	Door Seal Kit - CleanFire 300
6000031	Door Seal Only - CleanFire 300
2500622	Door Seal Kit - CleanFire 500
6000006	Door Seal Only - CleanFire 500
2500178	Door Seal Kit - CleanFire 700
6000032	Door Seal Only - CleanFire 700
4050036	Foam Bumper Pad, Door Switch - CleanFire models
8869	Bronze Silicone Adhesive

Rope, Door Seal

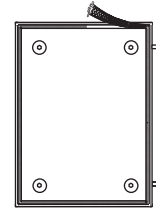

Sold either by the foot or in pre-cut lengths for specific model applications. Silicone is not included.

7674 Rope, 7/8", priced per ft

Chimney Sections, 8" - CleanFire 700

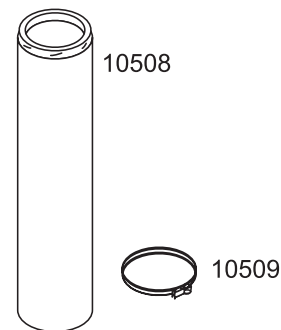

8" Stainless steel chimney currently shipped with CleanFire 700 models. Compatible with Chimney Extension (p/n 6500002). If connecting to Chimney Extension (p/n 6500002), use 8" Chimney Band Clamp Kit (p/n 4518) at the joints, not Chimney Snaplock Clamp (p/n 10509). For outdoor applications only. Not to be used for venting of indoor heating appliances.

10508	8" Chimney Extension, 4'
10509	Chimney Snaplock Clamp, 8"

CleanFire Furnace Parts & Accessories

Chimney Sections, 6" - CleanFire 300 and 500

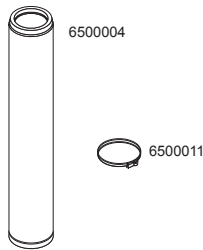

Type HT listed, factory-built, all stainless steel 6" chimney section. Sections are four feet long. Chimney Snaplock Clamp (6500011) should be used at each joint.

- 6500004 6" Chimney Extension, 4'
- 6500011 Chimney Snaplock Clamp, 6"

Chimney Cap/Spark Arrestor

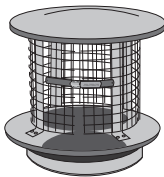

New version chimney cap/spark arrestor provides better fit, features a snaplock clamp and screen that is secured with a clamp-on fastener for easy removal. Available for 6" and 8" chimneys.

- 2900597 6" Chimney Cap, Spark Arrestor
- 2900598 8" Chimney Cap, Spark Arrestor

Chimney Band Clamp Kit, 6"



Reinforces strength between two sections of 6" chimney.

- 9535 Chimney Band Clamp Kit, 6"

Chimney Band Clamp Kit, 8"



Reinforces strength between two sections of 8" chimney.

- 4518 Chimney Band Clamp Kit, 8"

Chimney Attachment Ring

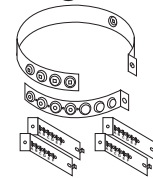

Used with electrical conduit (not included) to reinforce chimney when five or more sections are used. For 6" chimneys, must be located directly below 6" Chimney Locking Band (p/n 6500011) to reduce stress on the joint. For 8" chimneys, must be located directly below 8" Chimney Locking Band (p/n 10509) to reduce stress on the joint.

- 774 Chimney Attachment Ring

Chimney Guy-Wire Band, 6"

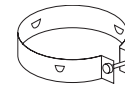

Attached to the outer casing of a 6" chimney to hold three guy-wires (not included). Recommended for chimneys exceeding the roof by 5' to 13' maximum.

- 776 Guy-Wire Band

Chimney Guy-Wire Band Kit, 8"



Used to provide additional stability to chimneys in installations where property damage could occur within the fall zone of the chimney. Guy wire is not included in kit.

- 778 Chimney Guy-Wire Band Kit

Chimney Tee Kits, Stainless Steel

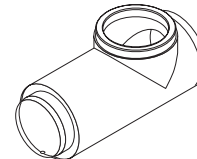

Type HT listed, factory-built, all stainless steel chimney tee. Kit includes chimney tee cover and chimney tee rope rings. NOTE: Silicone (p/n 806) is not included.

- 8" Chimney Tee Kit (p/n 2500621) - CleanFire 700.
- 6" Chimney Tee Kit (p/n 2500620) - CleanFire 300 and 500.

- 2500621 8" Chimney Tee Kit
- 2500620 6" Chimney Tee Kit

Chimney Tee Covers

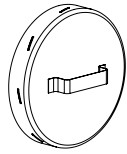

Replacement chimney tee cover.

- 10775 8" Cover - CleanFire 700
- 2900319 6" Cover - CleanFire 300 and 500

Chimney Rope Ring

Replacement rope ring for chimneys. See table below for applications. When ordering p/n 809, specify the length in feet.

Model	Rope Ring part number	
	Between chimney connector and furnace	Below first chimney section
CleanFire 700	6000033	7632
CleanFire 300/500	6000034	809 (order 2 ft)

- 6000033 Rope Ring (only), 2" Low Density Braid, 8" I.D.
- 6000034 Rope Ring (only), 1.75" Low Density Braid, 6" I.D.
- 7632 Rope Ring, 3/4", 8" ID
- 809 Door Seal Rope, 3/4", priced per ft

Refractory, Upper - CleanFire

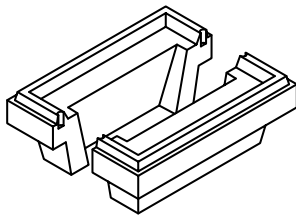

Replacement upper refractory for CleanFire models. Two (2) upper refractory are required per furnace. Replacement rope (p/n 809) required: 4 ft.

- 4050034 Refractory - Upper, CleanFire 700
- 4050033 Refractory - Upper, CleanFire 500
- 4050032 Refractory - Upper, CleanFire 300
- 809 Door Seal Rope, 3/4", priced per ft

Refractory, Fireball Tunnel

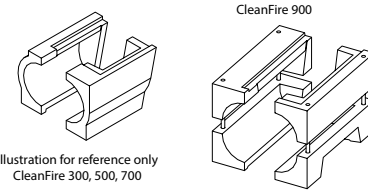

Replacement Fireball refractory for CleanFire models.

- 4050064 Refractory - Fireball, LH, CleanFire 700
- 4050065 Refractory - Fireball, RH, CleanFire 700
- 4050062 Refractory - Fireball, LH, CleanFire 500
- 4050063 Refractory - Fireball, RH, CleanFire 500
- 4050066 Refractory - Fireball, LH, CleanFire 300
- 4050067 Refractory - Fireball, RH, CleanFire 300

Combustion Air Tube

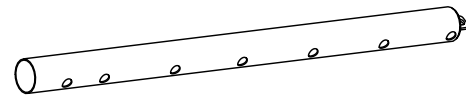

Replacement stainless steel combustion air tube and front bracket(s) for CleanFire models.

- 2500604 Combustion Air Tube Kit, CleanFire 700
- 2500603 Combustion Air Tube Kit, CleanFire 500
- 2500602 Combustion Air Tube Kit, CleanFire 300

Air Charge Tube

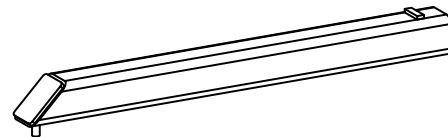

Replacement stainless steel air charge tube for CleanFire models.

- 1200857 Air Charge Tube, Stainless Steel, CleanFire 300
- 1200852 Air Charge Tube, Stainless Steel, CleanFire 500
- 1200317 Air Charge Tube, Stainless Steel, CleanFire 700

CleanFire Furnace Parts & Accessories

Air Channel, Front, Kit - CleanFire 700

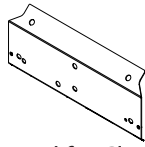

Replacement front air channel for CleanFire 700. Includes front air channel and hardware.

2500601 Air Channel Kit, Front - CleanFire 700

Air Channel, Front, Kit - CleanFire 500

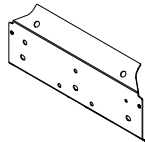

Replacement front air channel for CleanFire 500. Includes front air channel and hardware.

2500600 Air Channel Kit, Front - CleanFire 500

Air Channel, Front, Kit - CleanFire 300

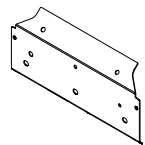

Replacement front air channel for CleanFire 300. Includes front air channel and hardware.

2500599 Air Channel Kit, Front - CleanFire 300

Elbow, Secondary Air Inlet, Rubber

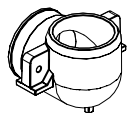

Replacement rubber elbow for secondary air inlet on CleanFire models. Use p/n 2500526 for primary air intake on CleanFire models.

5500016 Elbow, Secondary, Rubber

Elbow, Primary Air Inlet, Rubber

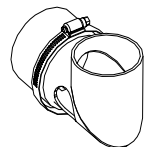

Replacement rubber elbow with ring insert for primary air inlet on CleanFire models (use p/n 5500016 for secondary).

2500526 Kit, Primary Air Inlet Elbow w/Ring Insert, Rubber

Door Rope and Seals - CleanFire



Tables below provides actual length; however, seal must be purchased in lengths of feet. Cutting may be required. When ordering, specify the length in feet.

Airbox Door Seal (p/n 8863)

All CleanFire Models	
Top/bottom pieces (x2)	19-3/8" (order 2 ft)
Side pieces (x3)	11.5" (order 1 ft)

Refractory Rope Seal (p/n 809)

CleanFire 300	37" (order 4 ft)
CleanFire 500	45" (order 4 ft)
CleanFire 700	47" (order 4 ft)

Ash Pan Rope Seal (p/n 809)

CleanFire 300	86" (order 8 ft)
CleanFire 500	99" (order 9 ft)
CleanFire 700	115" (order 10 ft)

Rear Cleanout Door Rope Seal (p/n 7674)

CleanFire 300	80" (order 7 ft)
CleanFire 500	88" (order 8 ft)
CleanFire 700	110" (order 10 ft)

Reaction Chamber Door Rope Seal (p/n 7674)

CleanFire 300	54" (order 5 ft)
CleanFire 500	54" (order 5 ft)
CleanFire 700	63" (order 6 ft)

809
7674
8863
8869

Door Seal Rope, 3/4", priced per ft
Door Seal Rope, 7/8", priced per ft
Seal, 3/16" x 3/4", priced per ft
Bronze Silicone Adhesive

Door Insulation, Rear Cleanout

Replacement insulation for rear cleanout door attached with metal straps on CleanFire models.

4050053 Insulation, Rear Door, Strap - CleanFire 300
4050056 Insulation, Rear Door, Strap - CleanFire 500
4050059 Insulation, Rear Door, Strap - CleanFire 700

CleanFire Furnace Parts & Accessories

Door Insulation, Inside Rear Cleanout

Replacement insulation for inside of rear cleanout door on CleanFire models.

- 4050052 Insulation, Rear Door - CleanFire 300
- 4050055 Insulation, Rear Door - CleanFire 500
- 4050058 Insulation, Rear Door - CleanFire 700

Door Cover Insulation, Rear

Replacement insulation for exterior cover of rear cleanout door on CleanFire models. Adhesive spray not included.

- 4050054 Insulation, Rear Door Cover - CleanFire 300
- 4050057 Insulation, Rear Door Cover - CleanFire 500
- 4050060 Insulation, Rear Door Cover - CleanFire 700

Sight Gauge Components

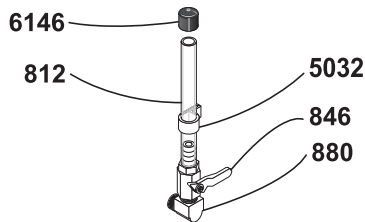

Sight Gauge Components replace original components.

- 812 Sight Gauge Tube, 9/16" OD x 3/8" ID
- 5032 Clip
- 846 Valve, 1/4"
- 880 Elbow, 1/4"
- 6146 Dust Cap

Latch, Pump Panel

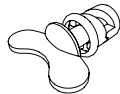

Replacement pump panel latch for CleanFire models.

- 5000446 Pump Panel Latch, CleanFire Models

Vent Cap

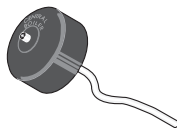

Replacement Vent Cap for CleanFire outdoor furnaces helps prevent water loss through the vent pipe.

- 320 Vent Cap

Scraper Tool

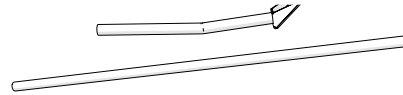

Used to maintain and clean the firebox.

- 2900534 Scraper Tool

Cleaning Rod - CleanFire



Used to clean the firebox.

- 9439 Cleaning Rod

Cleaning Tool, Heat Exchanger



Tool for cleaning CleanFire rear heat exchangers.

- 3105186-011 Heat Exchanger Cleaning Tool

Cleaning Tool, Afterburner

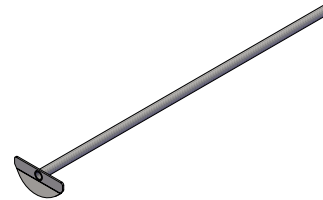

Tool for cleaning Afterburner and Reaction Chamber on CleanFire models.

- 1200897-011 Afterburner Cleaning Tool

Turbulator, Rear Heat Exchanger



Replacement turbulator for rear heat exchanger on CleanFire models. For CleanFire 700, 6 are required. For CleanFire 500 or 300, 5 are required.

- 3105291 Turbulator - CleanFire 700
- 3105279 Turbulator - CleanFire 500
- 3105297 Turbulator - CleanFire 300

Maxim Furnace Parts & Accessories

Grounding Rod Kit

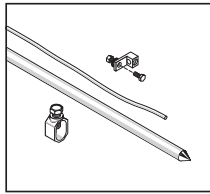

Used to electrically ground the furnace.

6593 Grounding Rod Kit

Ash Scoop - Maxim

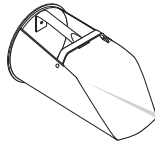

4-Quart galvanized Ash Scoop is ideal for cleaning ashes from furnace.

315 Ash Scoop

Flue Brush & Handle



Used to clean the flue passageways of M255 PE models. Flue Brush Kit (p/n 390) includes flue brush, extension rod and handle. Not to be used for cleaning 6" or 8" chimney.

390 Flue Brush Kit

Cleaning Rod - Maxim



Used to clean the firebox.

317 Cleaning Rod

Thermal Valve Replacement Components

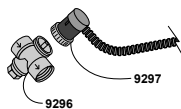

Replacement components for the thermal valve assembly on Maxim models.

9296 Thermal Valve Body Only - Maxim models
 9297 Thermal Valve Probe Assembly - Maxim models

Hopper, 48-Bushel Kit - Maxim

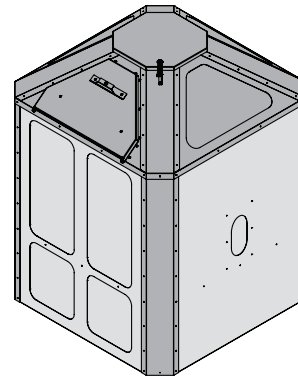

Increases fuel storage capacity, for Maxim models. Does not include auxiliary auger. Use the 5-1/2' Auxiliary Auger Kit (p/n 2500007) to locate the 48-Bushel Hopper to the side of the outdoor furnace. Available in either green and olive gray or terra brown and taupe to match the Maxim. Dimensions: 48" x 48" x 66".

9760 48-Bushel Hopper Kit - Green and Olive Gray
 9660 48-Bushel Hopper Kit - Terra Brown and Taupe

Auxiliary Auger Kits - Maxim

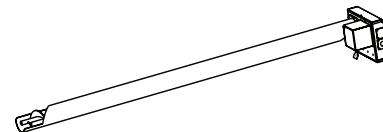

Transfer augers for external hoppers. Use 5-1/2' Auxiliary Auger Kit (p/n 2500007) with the 48-Bushel Hopper Kit (p/n 9660 or 9760) when the hopper is located to the side of the furnace. The 6' Auxiliary Auger Kit (p/n 2500008) and 8' Auxiliary Auger Kit (p/n 2500009) will not work with the 48-Bushel Hopper.

2500008 Auxiliary Auger Kit, 6'
 2500007 Auxiliary Auger Kit, 5-1/2'
 2500009 Auxiliary Auger Kit, 8'
 2000041 Replacement Gear Motor, Auxiliary Auger

Auger Flighting/Shaft



Replacement auger flighting/shaft for Maxim Auxiliary Auger Kits. Available in two different lengths.

9776 Auger Flighting/Shaft - 5-1/2'
 5569 Auger Flighting/Shaft - 6'

Bag Holder Kit - Maxim

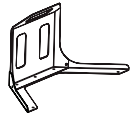

Bag Holder attaches to the inside of the door of the 48-Bushel Hopper to support bag of fuel.

9804 Bag Holder Kit

Hopper Vibrator Kit - Maxim

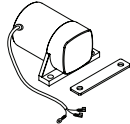

Vibrator attaches to the side of the Maxim's integrated hopper to keep fuel from bridging. Template provided.

9691 Hopper Vibrator Kit

Auxiliary Auger Vibrator w/Timer Kit - Maxim

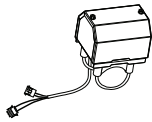

Vibrator is installed on the auxiliary auger connected to an external 43-bushel or 48-bushel hopper. For use with Auxiliary Auger Kits 2500007, 2500008 and 2500009 only. Vibration occurs based on timer setting.

9458 Auxiliary Auger Vibrator w/Timer Kit

Corn Aerator Kit - Maxim



Aerator is designed to optimize operation when burning corn. Paddles on the aerator are wear items; kit includes two additional paddles.

2500358 Corn Aerator Kit

Corn Aerator Paddle Kit - Maxim



Kit for adding paddles to aerator for burning corn. Kit requires welding paddles to existing aerator. Paddles on the aerator are wear items; kit includes two additional paddles.

2500359 Corn Aerator Paddle Kit

Maxim Furnace Parts & Accessories

Chimney Sections, 6" - Maxim



Type HT listed, factory-built, all stainless steel 6" chimney section. Sections are four feet long. Chimney Snaplock Clamp (6500011) should be used at each joint.

6500004 6" x 48" Chimney Extension
6500011 6" Chimney Snaplock Clamp

Chimney Lengths - Maxim

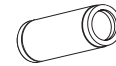

Three lengths of insulated chimney to obtain the required installation height. Features a 1/8-turn Twist-Lock assembly.

757 Chimney Length, 12"
758 Chimney Length, 24"
759 Chimney Length, 36"

Rope, Door Seal and Chimney Transition Box Cover



Rope is used for door or chimney transition box cover seal (each requires 5-ft). Sold by the foot, silicone not included.

809 Door Seal Rope, 3/4", priced per ft

Chimney Box Assembly

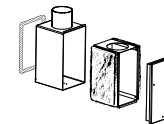

Replacement Chimney Box Assembly for M255 PE models.

2500054 Chimney Box Assembly - M255 PE

Chimney Box Cover Assembly



Maxim replacement chimney box cover assemblies.

2000181 Chimney Box Cover Assembly - M255 PE

Maxim Furnace Parts & Accessories

Insulation, Firebox Door - Maxim

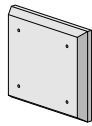

Replacement firebox door insulation for all M255 models.

4050022 Firebox Door Insulation, M255 PE

Controller, FireStar II - Maxim

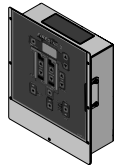

Replacement controller for M255 PE models.

2001280-SP FireStar II Controller for M255 PE

Motor, Burner Auger

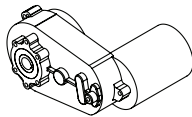

5800012 Burner Auger Motor
5013 Burner Auger Motor Key

Combustion Fan Kit

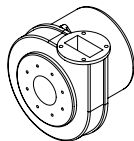

Combustion fan kit for Maxim M255 PE models. Kit includes combustion fan, gasket, decal and instructions for leveling the furnace.

2500181 Combustion Fan Kit, M255 PE models

Ignitor - M255 PE



Electric ignitor for Maxim M255 PE models.

2500298 Ignitor - M255 PE

Actuator Motor, Fuel Door



Replacement actuator motor with connectors for the fuel door on Maxim M 255 models.

2000182 Actuator w/Connectors

Motor, Isolation Auger - Kit

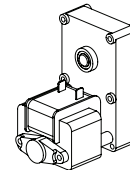

Replacement isolation auger motor with 1/8" gasket for Maxim furnaces. Motor operates at 4.1 rpm.

9373 Isolation Auger Motor Kit, (includes gasket), M255 PE

Connectors, Lever Nut



For easy connections of wires, in three configurations (5-lever connector shown).

8200277 Electrical Connector, 2-Lever
8200278 Electrical Connector, 3-Lever
8200279 Electrical Connector, 5-Lever

Switch, Paddle



Replacement paddle switch for Maxim Auxiliary Auger Kits.

4294 Paddle Switch, Auxiliary Auger

Transformer, 24V

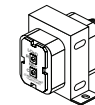

4045 24V Transformer

Snap Disc - Maxim



Replacement snap disc for M255 PE with s/n M210448 and later.
3533 Snap Disc, 185-225°F, (Back Burn)

Switch, Float - Water Level

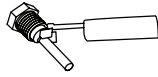

Replacement stainless steel water level float switch.
2500467 Water Level Float Switch, Stainless Steel

Sensor Kit, Water Temperature - Maxim



Replacement water temperature sensor for Maxim M255 PE models. Includes sensor and sensor lead wires, terminal block assembly, wire tie and instructions.
4302 Water Temperature Sensor Kit

Wiring Harness, Main

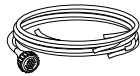

Replacement main wiring harness for M255 PE models.
2000603 Wiring Harness, Main - M255 PE models

Vent Cap

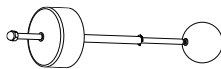

Replacement Vent Cap helps prevent water loss through the vent pipe and indicates water level.
9220 Vent Cap - M255 PE

Shock, Hopper Lid



Replacement Hopper Lid Shock for M255 PE models.
4265 Hopper Lid Shock

Maxim Furnace Parts & Accessories

Aerator

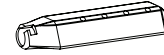

The aerator supplies oxygen to the fuel for the most complete combustion.
9710 Aerator, Stainless Steel

Burn Chamber w/Gasket - M255 PE

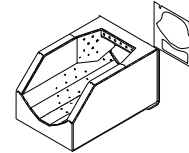

2500129 Burn Chamber w/Gasket, M255 PE models

Burn Chamber Gasket Only - M255 PE



6000026 Burn Chamber Gasket Only, M255 PE models

Burner Auger - M255 PE



9702 Burner Auger, M255 PE

Transfer Auger - M255 PE

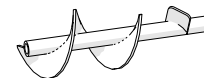

1200298 Transfer Auger, M250/M255 P/M255 PE

Inspection Window Components

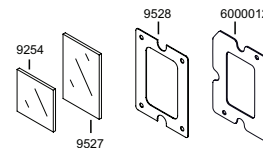

Replacement inspection window components for M255 PE inspection window.
9527 Inspection Window, 2" x 3"
6000012 Inspection Window Gasket

Numerical Parts Index

011-0002	Servomotor	40	0020-255	Tee, Black, 1"	23
011-0006	I/O Board	40	0020-257	Reducer Bushing, Black, 3/4" x 1"	23
011-0013	30 kW Control Panel Display	40	0020-258	Reducer Bushing, Black 1-1/2" x 1"	23
011-0016	60 kW Control Panel Display	40	0020-259	Reducer Bushing, Black, 3/8" x 1/2"	23
011-0036	Snap Disc	40	0020-260	Reducer Bushing, Black, 1" x 1/2"	23
011-0039	Display Knob	40	0020-261	Filter, Inline Screen - 1" FPT	7
011-0060	Solenoid	40	0020-291	Fill Valve and Inline Filter, Kit, Push-fit.	7
011-6004	Buffer Temperature Probe	40	0020-325	Fill Valve and Inline T-Strainer, Crimp	7
0020-002	Air Handler, 100k Btu, 1"	1	0020-345	Taco 2400-20 Circulating Pump	13
0020-003	Air Handler, 125k Btu, 1"	1	0020-346	Replacement Seal Kit, Taco 2400-20 pump	15
0020-004	Air Handler, 140k Btu, 1"	1	0020-351	Taco 0011 Circulating Pump.	13
0020-005	Air Handler, 160k Btu, 1"	1	0020-357	Replacement Cartridge, Taco 007 Pump	14
0020-006	Air Handler, 200k Btu, 1"	1	0020-365	Gasket, Isolation Flanges (each)	15
0020-022	Fan Coil Unit, 100k Btu, with Louvers	1	0020-366	Pump Isolation Flange, 1"	15
0020-023	Fan Coil Unit, 140k Btu, with Louvers	1	0020-376	Electronic Aquastat with 8' capillary	29
0020-024	Fan Coil Unit, 200k Btu, with Louvers	1	0020-377	Strap-On Aquastat (2E859)	29
0020-030	Speed Control for Fan Coil Units (p/n 0020-023) (p/n 0020-024)	1	0020-380	Low-Volt Thermostat, 24V	29
0020-031	Speed Control for Fan Coil Units (p/n 0020-022)	1	0020-382	Circuit Transformer	29
0020-041	Heat Exchanger Coil, 75k Btu	3	0020-402	Check Valve, 1"	30
0020-043	Heat Exchanger Coil, 100k Btu	3	0020-403	Brass Swing Check Valve, 1" FPT	30
0020-044	Heat Exchanger Coil, 125k Btu	3	0020-408	Tempering Valve, 3/4" Sweat	30
0020-045	Heat Exchanger Coil, 140k Btu	3	0020-410	Radiant Mixing Valve, 1" Sweat	30
0020-046	Heat Exchanger Coil, 160k Btu	3	0020-411	Radiant Mixing Valve, 3/4" Sweat.	30
0020-047	Heat Exchanger Coil, 200k Btu	3	0020-412	3-Way Zone Valve, 1" Sweat	30
0020-051	Plate Exchanger, 4.57" x 11.26"-20, 1" Port	5	0020-425	Antifreeze, Non-Toxic Boiler, 1 gal.	34
0020-052	Plate Exchanger, 4.57" x 11.26"-30, 1" Port	5	0020-426	Antifreeze, Non-Toxic Boiler, 5 gal	34
0020-053	Plate Exchanger, 4.57" x 11.26"-50, 1" Port	5	0020-427	Antifreeze, Non-Toxic Boiler, 55 gal.	34
0020-054	Plate Exchanger, 4.57" x 11.26"-60, 1-1/4" Port	5	0020-438	Multi-Purpose Stove and Soot Cleaner	34
0020-058	Water Heater Tube Kit.	6	0020-501	Sharkbite Coupling, 3/4"	25
0020-070	Baseboard, Complete, 2'	8	0020-502	Sharkbite Coupling, 1"	25
0020-072	Baseboard, Complete, 4'	8	0020-503	Sharkbite Reducer Coupling, 3/4" x 1/2"	25
0020-074	Baseboard, Complete, 6'	8	0020-505	Sharkbite Adapter, 1/2" Female.	25
0020-078	Baseboard End Cap, Left	8	0020-506	Sharkbite Adapter, 3/4" Female.	25
0020-079	Baseboard End Cap, Right	8	0020-507	Sharkbite Adapter, 1" Female	25
0020-081	Baseboard Corner, Outside	8	0020-509	Sharkbite Adapter, 3/4" MPT	25
0020-086	Heater, Kickspace, TK-70, 5638 Btu.	8	0020-510	Sharkbite Adapter, 1" MPT	25
0020-087	Heater, Kickspace, TK-90, 7350 Btu.	8	0020-511	Sharkbite Elbow, 1/2"	25
0020-088	Wall Mount Kit, Recessed - Kickspace Heater	8	0020-512	Sharkbite Elbow, 3/4"	25
0020-089	Wall Mount Kit, Surface - Kickspace Heater	8	0020-513	Sharkbite Elbow, 1"	25
0020-146	PEX Crimp Tool, 1"	21	0020-515	Sharkbite Tee, 1/2"	25
0020-147	Crimp Tool , 3/8" x 1" Compact Combination	21	0020-517	Sharkbite Tee, 1"	25
0020-150	PEX Coupling, 1" FPT Swivel x 1" PEX	20	0020-530	Sharkbite Coupling, Reducing, 1/2" x 3/4" MNPT.	25
0020-184	Brass Union, 1-1/4" FPT	22	0020-531	Sharkbite Coupling, Reducing, 1" x 3/4" MNPT	25
0020-185	Brass Coupler, 1" FPT	22	0020-532	Sharkbite 90° Elbow, Reducing, 3/4" x 1/2"	25
0020-186	Brass Nipple, 1" Short.	22	0020-534	Push-fit Disconnect Tongs, 1/2"	26
0020-187	Brass Tee, 1" FPT	22	0020-535	Push-fit Disconnect Tongs, 3/4".	26
0020-188	Brass Reducer Bushing, 1" x 1/2"	22	0020-536	Push-fit Disconnect Tongs, 1"	26
0020-189	Brass Reducer Bushing, 1-1/4" x 1".	22	0020-544	Sharkbite Ball Valve, 1"	25
0020-190	Brass Street 90° Elbow, 1"	22	0020-572	PEX Crimp Coupling, 1-1/4".	10
0020-192	Brass Reducer Bushing, 3/4" to 1"	22	0020-575	PEX Adapter, 1-1/4" MPT x 1-1/4" PEX.	10
0020-194	Brass 90° Elbow, 1" FPT	22	0020-576	PEX 90° Crimp Elbow, 1-1/4".	10
0020-195	Brass Adapter, 1/2" MIP x 3/4" FPT Hose Bib	22	0020-577	PEX Crimp Tee, 1-1/4"	10
0020-204	Brass Reducer Bushing, 1-1/2" x 1".	22	0020-578	PEX Crimp Plug, 1-1/4"	10
0020-205	Brass Coupler, 1-1/4"	22	0020-579	PEX Crimp Tee, 1-1/4" x 1-1/4" x 1".	10
0020-220	90° Reducing Elbow, 3/4" x 1" sweat fitting	27	0020-580	PEX Crimp Ring, 1-1/4"	10
0020-221	90° Elbow, 3/4" sweat fittings	27	0020-650	E-Z Lay 3-wrap Insulated Pipe, 1" x 250' Roll.	10
0020-222	90° Elbow, 1" sweat fittings	27	0020-651	E-Z Lay 3-wrap Insulated Pipe (regular non-barrier), 1" - per foot	10
0020-224	90° Street Elbow, 1" sweat fitting.	27	0020-652	E-Z Lay 3-wrap Insulated Pipe, 1-1/4" x 250' Roll	10
0020-225	Coupling, 3/4" MPT x 3/4" female sweat fitting	27	0020-653	E-Z Lay 3-wrap Insulated Pipe, 1-1/4" - per foot	10
0020-226	Coupling, 3/4" MPT x 1" female sweat fitting	27	0020-654	E-Z Lay 3-wrap Insulated Pipe, 1" x 100' Roll.	10
0020-227	Coupling, 1" MPT x 1" female sweat fitting.	27	0020-655	E-Z Lay 3-wrap Insulated Pipe, (oxygen barrier), 1" - per foot	10
0020-228	Reducer, Copper, 3/4" x 1" sweat fitting	27	0020-656	E-Z Lay 5-wrap Insulated Pipe, 1" - per foot	10
0020-230	Tee, 1" sweat fitting	28	0020-772	Stainless Steel Brush, 2" x 36" for tube cleaning	42
0020-231	Copper Tee, 2" x 1" x 1"	28	0020-777	Glass Cover, Night Light	36
0020-233	Coupling, 1" male sweat x 1" FPT fitting	27	0020-800	Auger Chain, 4400	37
0020-250	Nipple, Black, 1" x 2".	23	0020-801	Auger Chain, 5500	37
0020-251	1" x 3" Black Nipple	23	021-0056	Leveling Foot	40
0020-252	Nipple, Short Black, 3/8" x 1-1/2"	23	021-0501	Mounting Hardware, Display	40

021-8322	Mounting Hardware, Display	40	124	45° Street Elbow, 3/4"	23
041-0006	Heat Exchanger Gasket, 60 kW	39	126	90° Street Elbow, Brass, 3/4"	24
041-0028	Door Handle.	39	130-0001	Auger Motor, Feed, 5.3 RPM	41
041-3022	Heat Exchanger Gasket, 30 kW	39	133	Tee, Black, 3/4" NPT	23
050-0008	Bearing, Heat Exchanger Motor	39	138	Tee, Copper Pipe, 1" x 1" x 1" sweat fittings	28
050-0027	Door Hinge	39	140	Tempering Valve, 3/4" sweat fittings	31
050-1085	Door Handle, LH	39	146	Copper Coupling, 3/4" sweat x 3/4" sweat fittings	27
071-3001	Door Rope Seal, Top Door, 30kW	39	147	Copper Coupling, 1" sweat x 1" sweat fittings.	27
071-3002	Door Rope, Top Door, 30k	39	153	Litmus Paper	34
071-3003	Door Rope, Ash Door, 30k	39	154	Blower & Motor, 1/4-hp, 3-speed fan	2
071-6001	Door Rope Seal, Ash Door, 60kW	39	160-0000	Ignitor, 400W	41
071-6002	Door Rope, Top Door, 60k	39	164	Female Adapter, 1" sweat x 3/4" FIP fittings	28
071-6003	Door Rope, Top Door, 60kW	39	166	Sludge Conditioner, 1 gal.	34
097-3000	Firebox Door Latch	39	174	Temperature Gauge, 1/2" MPT	24
100-0017	Air Compressor	41	175	Taco 006 Bronze Pump	13
100-0035	Snap Disc, Renovator 20	41	178	Reducing Tee, 1-1/2" x 1" x 1" sweat fittings.	28
100-0037	Photosensor.	41	180	Hex Bushing, 3/4" x 1/8"	23
100-0038	Fuse, 3.15A.	41	186	Ball Valve, 1/2"	31
100-0043	Temperature Control, Renovator.	41	188	24-Volt Transformer	29
100-0048	Relay, Renovator	41	194	Pump Flange Kit, 1"	15
100	Soldering Flux (6 oz).	28	198	Ball Valve, 3/4" FIP Full Port	31
102	Heat Exchanger Coil, 95k Btu	4	199	Brass Hose Bib, 3/4" MPT	31
103	Street Elbow, 1"	27	200	Sweat Ball Valve, 3/4" x 3/4" sweat fitting - Lead Free	31
104	Clamp Crimp Ring Removal Tool	21	203	Blower & Motor, 1/15-hp	2
106	Heat Exchanger Coil, 100k Btu, 3/4" FPT	4	208	Blower & Motor, 1-hp, 3-speed fan.	2
107	Heat Exchanger Coil, 125k Btu, straight outlets.	4	0209-252	Morris Coupling	38
108	Heat Exchanger Coil, 140k Btu	4	0209-254	Morris Coupling Gasket Seal	38
0109-001	Dixell Temp Control	35	0209-400	Ash Scoop Handles	40
0109-002	Thermistor, Digital Aquastat.	36	0209-500	Draft Spring	35
0109-003	Thermowell, 1/2"	36	0219-021	Lock Nut, Center, 5/16"-18 (requires 4 per panel)	35
0109-009	Thermistor, Digital Aquastat, AFS 900.	36	222	Replacement Cartridge, 006 Series Pumps	14
0109-010	Thermocouple, AFS 900	38	224	"Free Floating" Flange Kit, 3/4"	15
0109-045	Dixell Face Plate	35	225	Isolation Flange Kit, 1-1/4"	15
0109-100	Float Assembly, Water Level Light	36	226	Isolation Flange with Drain Valve, 3/4"	15
0109-101	Snap Disc	35	231	Reducer, Copper Pipe, 1" x 3/4" sweat fittings.	27
0109-152	Fan Switch, ON/OFF.	35	251-2390	Primary Air Plate, 30 kW	39
0109-152	Switch, Fan On/Off.	36	251-5090	Primary Air Plate, 60 kW	39
0109-153	Switch, Light On/Off.	36	255	Tee, Copper, 3/4" sweat fitting	28
0109-191	Water Pressure Switch, 4"	36	274	90° Street Elbow, 3/4"	24
0109-192	Water Pressure Switch, 1-1/4"	36	276	90° Elbow, 3/4" x 3/4" sweat fittings	27
0109-194	Air Pressure Switch, AFS 900	38	277	90° Elbow, 1" x 1" sweat fittings.	27
0109-245	Water Level Light Receptacle, Green LED	36	286	Automatic Vent Valve	30
0109-401	ETC Wire Harness, Wood Stoves	36	287	Heat Exchanger Coil, 50k Btu	4
0109-411	Stove Harness, Single Blower - 3300/4400	36	293	PEX Hanger, 1/2"	21
0109-412	Stove Harness, Double Blower - 5500	36	295	PEX Hanger, 1"	21
0109-413	Stove Harness - 6500	36	296	Brass Swing Check Valve, 3/4".	30
0109-601	Ignitor, AFS 900 (800 Watt).	38	301	Air Handler Cabinet, 100k-140k Btu, front access	2
0109-620	Temperature Probe, LT 90 RTD	36	303	Air Handler Cabinet, 185k-220k Btu, front access	2
0109-701	Motor, AFS 900	38	306	Radiant Mixing Valve, 1/2" NPT fittings	31
0109-702	Motor, AFS 1100	38	314	Nipple, 1-1/2" x close, Schedule 80, extra heavy	23
0109-710	Heat Exchanger Motor	39	315	Ash Scoop	49
0109-730	Replacement Fan (4C012) - 3300, old 434	35	317	Cleaning Rod - Maxim	49
0109-731	Replacement Fan (4C004) - 3300, 434, 5500 (rear), AFS 900 and LT90	35	320	Vent Cap	48
0109-732	Replacement Fan (4C446) - 4400, 5500, 546, 6500, 658 & AFS1100	35	327	Radiant Mixing Valve, 3/4" NPT fittings	31
0109-734	Draft Inducer, LT 90 and AFS models	33	329	Radiant Mixing Valve, 1" NPT fittings	31
0109-739	Draft Fan and Capacitor	40	331	Pipe Plug, 3/4"	24
0109-790	Solenoid, Laminated	35	332	3/4" Round Pipe Cap	24
109	Heat Exchanger Coil, 80k Btu	4	333	1-1/4" Round Pipe Cap	24
110	Heat Exchanger Coil, 185k Btu	4	336	Pipe Plug, 1-1/2"	24
111	Heat Exchanger Coil, 220k Btu	4	351-6800	Wood Grate Insert, 60 kW	39
112	Vent Elbow, 1" x 1" sweat fittings.	27	351-6990	Pellet Grate Insert, 60 kW	39
116	Male Adapter, 3/4" sweat x 3/4" MIP fittings.	27	351-7000	Pellet Grate Insert, 30 kW	39
117	Female Adapter, 3/4" sweat x 3/4" FIP fittings.	28	351-8540	Wood Grate Insert, 30 kW	39
118	Nipple, 3/4" x close, Schedule 80, extra heavy	23	368	Plug-in Thermostat	29
119	Pump Flange Kit, 3/4".	15	372	Vent Elbow, 3/4" x 3/4" sweat fittings.	27
120-0003	Combustion Fan, Renovator.	41	376	Copper End Cap, 1" sweat fitting.	27
120	Male Adapter, 1" sweat x 1" MPT fittings	27	378	Cleaning Brush, 3/4".	28
123	90° Reducing Elbow, 1" x 3/4" sweat fittings.	27	379	Cleaning Brush, 1"	28

Numerical Parts Index

380	Male Adapter, 1-1/4" barb x 1-1/4" MIP	12	778	Chimney Guy-Wire Band Kit	45
381	Brass Coupling, 1-1/4" barb x 1-1/4" barb	12	800-0011	Auger Spiral	41
382	Brass Elbow, 1-1/4" barb x 1-1/4" barb	12	800-0116	Burn Pot, Renovator 20	41
383	Pipe Plug, 1-1/4"	24	800-0122	Auger T-Pipe	41
385	Brass Hex Bushing, 1-1/2" x 3/4"	22	800-0133	Burn Pot, Renovator 30	41
386	PEX 1-1/4" Pipe, 328'	12	806	Black Silicone Adhesive, High Temperature, 10.1 oz.	35
390	Flue Brush Kit	49	0809-012	Fire Pot, AFS 900	38
408	Hex Bushing, 1-1/2" x 1-1/4"	23	0809-334	Slide Rod Plate, 3300	37
0409-003	ETC Back Box	35	0809-400	Ash Grate, 4400	37
0409-013	Firebox Handle	39	0809-403	Triple Ash Auger WMT, Inside (Center Auger), 4400	37
0409-027	ETC Gasket	35	0809-404	Triple Auger Assembly, 4400	37
0409-212	Boot, Steel/Plastic Hopper	41	0809-444	Slide Rod Plate, 4400	37
409	Nipple, 1-1/4" x close, Schedule 80, extra heavy	23	0809-500	Ash Grate, 5500	37
411	90° Street Elbow, 1-1/4"	24	0809-503	Triple Ash Auger WMT, Inside (Center Auger), 5500	37
418	Tee, Black, 1-1/4" NPT	23	0809-504	Triple Auger Assembly, 5500	37
430-0007	Shroud, Renovator	41	0809-554	Slide Rod Plate, 5500	37
430-0008	Hose, Blue Intake	41	0809-654	Slide Rod Plate, 6500	37
430-0011	Auger Pipe	41	809	Door Seal Rope, 3/4", priced per ft	46
430-0015	Hose, Air Compressor	41	809	Door Seal Rope, 3/4", priced per ft	46
430-0021	ETC Cover UV Shield	35	809	Door Seal Rope, 3/4", priced per ft	47
515	Fan Center Relay	29	809	Door Seal Rope, 3/4", priced per ft	50
535	Nipple, Brass, 3/4" x 2"	22	812	Sight Gauge Tube, 9/16" OD x 3/8" ID	48
536	Nipple, Brass, 3/4" x 7"	22	846	Valve, 1/4"	48
542	O-Ring Set, Taco Pump Flange	15	880	Elbow, 1/4"	48
551-3005	Funnel, 30 kW	39	0909-401	Crank Handle, Ash Auger (fits all models)	37
551-6005	Funnel, 60 kW	39	0909-653	Slide Rod, 6500	37
555	Power Supply Cord, 48"	15	956	90° Elbow, 3/4" x 3/4" FPT	24
556	Power Supply Cord, 32"	15	1097	Universal 5x12 Plate Heat Exchanger Mounting Kit	5
574	Pipe Plug, Brass 3/4"	24	1267	Line Voltage Thermostat	29
603	Panel Radiator, 55-1/4" x 24"	8	1311	Central PEX 1" Pipe, 100'	12
604	TRV II Valve Body and Head, 1/2" Vertical	8	1312	Central PEX 1" Pipe, 200'	12
605	LKD Valve Body with No Cap, 1/2" Preset Flow Rate	8	1313	Central PEX 1" Pipe, 300'	12
606	Push-fit Coupling, Straight, 1/2" x 1/2"	26	1314	Central PEX 1" Pipe, 500'	12
607	Push-fit Coupling, Straight, 3/4" x 3/4"	26	1320	Central PEX 1/2" Pipe, 300'	17
608	Push-fit Coupling, Straight, 1" x 1"	26	1321	Central PEX 1/2" Pipe, 500'	17
0609-023	Fire Pot Front Plate, AFS 900	38	1322	Central PEX 1/2" Pipe, 1000'	17
0609-500	High Temperature Auger, AFS 900	38	1324	PEX Adapter, 1" PEX x 1" MIP fittings	20
609	Push-fit Coupling, Reducing, 1" x 3/4"	26	1325	Solder	28
610-0367	Flame Guard	41	1330	PEX Adapter, 1" PEX x 3/4" MIP fittings	20
610-0369	Auger Feed Hose Adapter, Renovator 20	41	1331	PEX Adapter, 1" PEX x 3/4" or 1" sweat fitting	20
610-0370	Auger Intake Pipe	41	1332	PEX Tee, 1"	20
0611-022	Front Plate, AFS 1100	38	1333	PEX Coupling, 1"	9
0611-512	High Temperature Auger, LH, AFS 1100	38	1333	PEX Coupling, 1"	12
0611-513	High Temperature Auger, RH, AFS 1100	38	1334	PEX 90° Elbow, Brass, 1"	20
611	Push-fit Female Adapter, 1" x 1" FPT	26	1335	Crimp Ring, 1" PEX	20
612	Push-fit Male Adapter, 1" x 3/4" MPT	26	1336	PEX Adapter, 1/2" PEX x 3/4" MIP fittings	20
613	Push-fit Elbow, 1" x 1"	26	1337	PEX Adapter, 1/2" PEX x 1/2" sweat fitting	20
614	Push-fit Tee, 1" x 1" x 1"	26	1338	PEX Tee, 1/2"	20
615	Push-fit Depth Gauge/Deburring Tool	26	1339	PEX Coupling, 1/2"	12
616	Push-fit Disconnect Clip, 1/2"	26	1340	PEX 90° Elbow, Brass, 1/2"	20
617	Push-fit Disconnect Clip, 3/4"	26	1341	PEX Adapter, 1/2" PEX x 1/2" MIP fittings	20
618	Push-fit Disconnect Clip, 1"	26	1348	PEX Adapter, 1/2" PEX x 1/2" FIP fitting	20
0699-118	Return Line Pipe, AFS 1100	38	1350	Push-fit Temperature Gauge Fitting, 1" x 1/8" NPT	26
700-0078	Auger Feed Motor Assembly, Renovator 20	41	1366	Pump Wall Mount Kit	15
704	Heat Exchanger Coil, 125k Btu, 90° outlets	4	1694	Y-Strainer, 1-1/4" Black	7
0709-051	Fan Cover, WoodMaster Models and LT 90	35	1695	Y-Strainer, 3/4" - Brass	7
0709-100	10" Twist-Lock Chimney Cap	33	1709-060	6" Chimney Cap	32
0709-102	10" Twist-Lock Male Coupler	33	1709-061	6" Cover Cap	32
0709-104	10" x 24" Twist-Lock Stainless Steel Chimney	33	1709-062	6" Chimney Male Coupler	32
0709-105	10" x 48" Twist-Lock Stainless Steel Chimney	33	1709-063	Chimney Spark Arrestor Mesh, 6"	32
0709-130	Twist-Lock Spark Arrestor Mesh	33	1709-064	6" x 24" SuperPro SS Chimney	32
727	Water Temperature Sensor Kit, CleanFire models	44	1709-065	6" x 48" SuperPro SS Chimney	32
757	Chimney Length, 12"	50	1709-067	6" Chimney Tee w/Plug	32
758	Chimney Length, 24"	50	1709-068	6" x 30° Chimney Elbow Kit	32
759	Chimney Length, 36"	50	1709-069	6" Chimney Locking Band	32
774	Chimney Attachment Ring	45	1709-080	8" Chimney Cap	32
776	Guy-Wire Band	45	1709-081	8" Cover Cap	32
778	Chimney Guy-Wire Band Kit	32	1709-082	8" Male Coupler	32

1709-083	Chimney Spark Arrestor Mesh, 8"	32	7992-110	Firebox Door Assembly, AFS900/1100/LT90	35
1709-084	8" x 24" SuperPro SS Chimney	32	7992-328	Auger Tube Cover w/Ash Drop Out Door.	37
1709-085	8" x 48" SuperPro SS Chimney	32	7992-329	Ash Hoe	42
1709-086	8" x 30° Chimney Elbow Kit	32	7992-332	Slide Rod Assembly, 3300	37
1709-087	8" Chimney Tee w/Plug	32	7992-442	Slide Rod Assembly, 4400	37
1709-089	8" Chimney Locking Band	32	7992-444	Ash/Auger Kit, 4400	37
2053	Fittings Kit	6	7992-552	Slide Rod Assembly, 5500	37
2441	ThermoPEX, 1", 100' Roll	9	7992-554	Ash/Auger Kit, 5500	37
2443	ThermoPEX Cap, 1"	9	7992-652	Slide Rod Assembly, 6500	37
2447	ThermoPEX Coupling Kit, 1"	9	7992-657	Firebox Door, 6500, LH	35
2491	ThermoPEX, 1", 800' Roll	9	7992-658	Firebox Door, 6500, RH	35
2492	ThermoPEX, 1-1/4", 300' Roll.	9	7992-795	Actuator, AFS 900	38
2494	ThermoPEX Cap, 1-1/4"	9	7992-901	ETC Panel Assembly, Wood Stove	35
2495	ThermoPEX Coupling Kit, 1-1/4"	9	7995-013	Fire Pot With End Plate, AFS 1100	38
2657	Digital Pocket Multimeter	42	8113	Lens w/Gasket	43
2799	ThermoPEX, 1-1/4", 100' Roll.	9	8863	Seal, 3/16" x 3/4", priced per ft	47
3042	Brass Hex Bushing, 1/2" x 1/8"	22	8869	Bronze Silicone Adhesive	44
3533	Snap Disc, 185-225°F, (Back Burn)	52	8869	Bronze Silicone Adhesive	47
3822	Kit for 301 - back water access	2	8932	Door Switch	43
3825	Kit for 303 - back water access	2	9220	Vent Cap - M255 PE	52
3850	Tee, Brass, 3/4" NPT	23	9263	Push-fit Fittings Water Heater Kit.	6
3851	Brass Hex Bushing, 1-1/4" x 3/4"	22	9264	Push-fit Connector, Straight, 3/4" x 3/4" MIP	26
4045	24V Transformer	51	9265	Push-fit Elbow, 3/4" x 3/4"	26
4265	Hopper Lid Shock	52	9296	Thermal Valve Body Only - Maxim models.	49
4294	Paddle Switch, Auxiliary Auger	51	9297	Thermal Valve Probe Assembly - Maxim models	49
4302	Water Temperature Sensor Kit	52	9373	Isolation Auger Motor Kit, (includes gasket), M255 PE	51
4472	Ratchet Cinch Tool	21	9439	Cleaning Rod - CleanFire	48
4518	Chimney Band Clamp Kit, 8".	32	9458	Auxiliary Auger Vibrator w/Timer Kit	50
4518	Chimney Band Clamp Kit, 8".	45	9527	Inspection Window, 2" x 3"	52
4519	Chimney Base Brace Kit, 8".	32	9535	Chimney Band Clamp Kit, 6".	45
4928	Brass Adapter, 3/4" female hose x 3/4" male pipe	23	9624	Tee, Brass, 3/4"	22
4929	Brass Adapter, 3/4" male hose x 3/4" male pipe	23	9660	48-Bushel Hopper Kit - Terra Brown and Taupe.	49
5013	Burner Auger Motor Key	51	9691	Hopper Vibrator Kit	50
5032	Clip	48	9702	Burner Auger, M255 PE.	52
5348	Cap, Brass, 3/4"	31	9710	Aerator, Stainless Steel	52
5349	Washer, 3/4".	31	9760	48-Bushel Hopper Kit - Green and Olive Gray.	49
5367	Brass Coupling, 3/4" thread	22	9776	Auger Flighting/Shaft - 5-1/2'.	49
5459	Pipe Plug Wrench Set	24	9804	Bag Holder Kit	50
5569	Auger Flighting/Shaft - 6'	49	10508	8" Chimney Extension, 4'	44
5634	Plate Exchanger, 10 x 20-40, 1-1/2" Port	5	10508	8" x 48" Twist-Lock Stainless Steel Chimney	33
5642	Brass Clamp Fittings, 1"	12	10509	Chimney Snaplock Clamp, 8"	44
5643	Brass Clamp Fittings, 1-1/4" PEX Pipe (SDR-11)	12	10509	Clamp, Snaplock Chimney - 8"	32
5670	PEX 1-1/4" Pipe, 150'.	12	10775	8" Cover - CleanFire 700	46
5807-011	Plate Mounting Bracket	5	11220	Rocker Switch, Power Supply (on-off), 5A breaker.	43
5871	Brass Swing Check Valve, 1-1/4"	30	20905	PureLink Non-Barrier PEX-A, 1/2" x 1000'.	17
5907	Brass Pipe Union, 3/4".	22	56200	HeatLink Manifold Actuator w/LED	18
5908	Brass Pipe Union, 1"	22	56201	HeatLink Valve Zone Drive Actuator w/LED	18
5909	Brass Pipe Union, 1-1/4"	22	56202	HeatLink Multiport Manifold Actuator w/LED.	18
5925	Cinch Tool	21	56231	HeatLink Valve Actuator w/LED.	18
5926	PEX Stainless Steel Clamp Crimp Ring, 1"	21	57094	Thermostatic Head, 1"	18
5927	PEX Stainless Steel Clamp Crimp Ring, 1/2"	21	62025	Zone Valve, Straight 1"	18
5958	Temperature Sensor Well.	44	64026	Mixing Valve, 1" x 4-way FNPT	18
6054	Temperature Gauge, 1/8" MPT	24	77005	PEX Connector, 1/2" (pair)	18
6146	Dust Cap	48	77019	PEX Connector, 5/8" (pair)	18
6509	Light Bulb, 40 W	43	78200	TwistSeal Mini Deluxe Supply/Return Module	18
6557	Pipe Plug, Brass 1/2".	24	78302	TwistSeal Mini 2-Port Module Pair	19
6593	Grounding Rod Kit.	49	78303	TwistSeal Mini 3-Port Module Pair	19
6679	Female Adapter, 1/2" barb x 1/2" sweat fittings	20	79200	TwistSeal Mini Manifold Assembly Kit.	19
6764	Brass Offset Tee, 4".	22	87024	Aluminum Heat Transfer Plate, 24".	19
6782	Brass Diverter Tee, 1" x 1" x 1/2" sweat	27	94305	HeatLink O2 Barrier PEX-A Tubing, 1/2" x 300'	17
7594	Door Rope, 1" Fiberglass, Firebox - Per Foot (250' per box)	35	1200298	Transfer Auger, M250/M255 P/M255 PE	52
7632	Rope Ring, 3/4", 8" ID	46	1200317	Air Charge Tube, Stainless Steel, CleanFire 700	46
7674	Door Seal Rope, 7/8", priced per ft	47	1200852	Air Charge Tube, Stainless Steel, CleanFire 500	46
7674	Rope, 7/8", priced per ft	44	1200857	Air Charge Tube, Stainless Steel, CleanFire 300	46
7992-021	Vent Cap	37	1200897-011	Afterburner Cleaning Tool	48
7992-033	Breakaway Slide Rod Assembly, 3300.	37	2000041	Replacement Gear Motor, Auxiliary Auger.	49
7992-044	Breakaway Slide Rod Assembly, 4400.	37	2000181	Chimney Box Cover Assembly - M255 PE.	50
7992-055	Breakaway Slide Rod Assembly, 5500.	37	2000182	Actuator w/Connectors.	51

Numerical Parts Index

2000603	Wiring Harness, Main - M255 PE models	52	2900619	PEX Pipe Cutter	21
2000737	Combustion Fan	43	2900631	MolyArmor 350 Corrosion Inhibitor, 1 gal.	34
2001241	Stepper Motor Assembly	43	2900632	Moly Test Strips, qty. 25	34
2001269-SP	FireStar Controller for CleanFire	44	3104665	Mounting Bracket, 55k Btu Pool Heat Exchangers	7
2001280-SP	FireStar II Controller for M255 PE	51	3104940	Mounting Bracket, 155k/300k/360k Btu Pool Heat Exchangers	7
2500007	Auxiliary Auger Kit, 5-1/2'	49	3104941	Mounting Bracket, 600k Btu Pool Heat Exchangers	7
2500008	Auxiliary Auger Kit, 6'	49	3104942	Mounting Bracket, 1200k Btu Pool Heat Exchangers	7
2500009	Auxiliary Auger Kit, 8'	49	3105186-011	Heat Exchanger Cleaning Tool	48
2500054	Chimney Box Assembly - M255 PE	50	3105279	Turbulator - CleanFire 500	48
2500129	Burn Chamber w/Gasket, M255 PE models	52	3105291	Turbulator - CleanFire 700	48
2500164	Pump Panel Extension Kit	43	3105297	Turbulator - CleanFire 300	48
2500172	ThermoPEX Coupling Kit, 25mm	9	4050022	Firebox Door Insulation, M255 PE	51
2500177	Door Seal Kit - CleanFire 300	44	4050032	Refractory - Upper, CleanFire 300	46
2500178	Door Seal Kit - CleanFire 700	44	4050033	Refractory - Upper, CleanFire 500	46
2500181	Combustion Fan Kit, M255 PE models	51	4050034	Refractory - Upper, CleanFire 700	46
2500195	Door Latch Bushing Kit	44	4050036	Foam Bumper Pad, Door Switch - CleanFire models	44
2500298	Ignitor - M255 PE	51	4050052	Insulation, Rear Door - CleanFire 300	48
2500299	Heat Exchanger Mounting Kit	5	4050053	Insulation, Rear Door, Strap - CleanFire 300	47
2500358	Corn Aerator Kit	50	4050054	Insulation, Rear Door Cover - CleanFire 300	48
2500359	Corn Aerator Paddle Kit	50	4050055	Insulation, Rear Door - CleanFire 500	48
2500467	Water Level Float Switch, Stainless Steel	43, 52	4050056	Insulation, Rear Door, Strap - CleanFire 500	47
2500526	Kit, Primary Air Inlet Elbow w/Ring Insert, Rubber	47	4050057	Insulation, Rear Door Cover - CleanFire 500	48
2500582	Thermocouple Kit, Universal - CleanFire models	43	4050058	Insulation, Rear Door - CleanFire 700	48
2500595	CleanFire Kit for Delivery Trailer	42	4050059	Insulation, Rear Door, Strap - CleanFire 700	47
2500598	Moly/pH Test Kit, Complete	34	4050060	Insulation, Rear Door Cover - CleanFire 700	48
2500599	Air Channel Kit, Front - CleanFire 300	47	4050062	Refractory - Fireball, LH, CleanFire 500	46
2500600	Air Channel Kit, Front - CleanFire 500	47	4050063	Refractory - Fireball, RH, CleanFire 500	46
2500601	Air Channel Kit, Front - CleanFire 700	47	4050064	Refractory - Fireball, LH, CleanFire 700	46
2500602	Combustion Air Tube Kit, CleanFire 300	46	4050065	Refractory - Fireball, RH, CleanFire 700	46
2500603	Combustion Air Tube Kit, CleanFire 500	46	4050066	Refractory - Fireball, LH, CleanFire 300	46
2500604	Combustion Air Tube Kit, CleanFire 700	46	4050067	Refractory - Fireball, RH, CleanFire 300	46
2500620	6" Chimney Tee Kit	45	5000016	90° Elbow, Black, 1-1/4"	24
2500621	8" Chimney Tee Kit	45	5000017	45° Street Elbow, 1-1/4"	23
2500622	Door Seal Kit - CleanFire 500	44	5000378	Valve Head, 1/2" Vertical, TRV II	8
2500633	24V Fan Conversion Kit - CleanFire 300, 500, 700	42	5000392	Water Heater Mixing Valve, 3/4" NPT fittings, lead free	31
2700282	Firebox Door, 3300/434	35	5000394	Nipple, Brass, 3/4" x 4"	22
2700283	Firebox Door, 4400/546	35	5000446	Pump Panel Latch, CleanFire Models	48
2700284	Firebox Door, 5500	35	5000462	PEX Coupling, 25mm	12
2900001	Hoe, Firebox, 72"	42	5000464	Brass PEX Adapter, 25mm x 3/4" NPT	20
2900319	6" Cover - CleanFire 300 and 500	46	5000465	PEX Stainless Steel Clamp Crimp Ring, 25mm	21
2900325	Outdoor Torch	42	5000531	Brass PEX Adapter, 1" PEX x 3/4" MPT fittings, 90° Elbow	20
2900341	Universal Crimp Tool, 14-24 AWG	21	5000556	Ball Valve, 1/2" PEX, Full Port	31
2900534	Scraper Tool	48	5000557	Ball Valve, 1" PEX, Full Port	31
2900544	Fan Coil Unit, 50k Btu	1	5000557	Ball Valve, 1" PEX x 1" PEX, Full Port	20
2900545	Fan Coil Unit, 100k Btu	1	5000651	PEX Adapter, 1" PEX x 1" sweat fitting	20
2900546	Fan Coil Unit, 220k Btu	2	5000661	Ball Valve, 1" FIP	20
2900549	Thermal Actuator, 2-wire	16	5000673	O-ring, Manifold	16
2900550	Thermal Actuator, 4-wire	16	5000683	O-Ring, Replacement, for Hot Water Filter (p/n 2900578)	42
2900551	Loop Cap, Manifold	16	5500014	ThermoPEX Cap, 25mm	9
2900552	Manifold Kit, 2-Loop	16	5500016	Elbow, Secondary, Rubber	47
2900553	Manifold Kit, 3-Loop	16	5600001	Plate Exchanger, 5 x 12-50, 1-1/4" Port	5
2900554	Manifold Kit, 4-Loop	16	5600002	Plate Exchanger, 5 x 12-70, 1-1/4" Port	5
2900556	Manifold Kit, 6-Loop	16	5600003	Plate Exchanger, 5 x 12-6, 3/4" Port	5
2900558	Manifold Kit, 8-Loop	16	5600004	Plate Exchanger, 5 x 12-30, 3/4" Port	5
2900560	Manifold Kit, 10-Loop	16	5600005	Pool Heat Exchanger, 316L, 55k Btu	6
2900562	Manifold Kit, 12-Loop	16	5600006	Pool Heat Exchanger, 316L, 155k Btu	6
2900563	Connector, Compression, 1/2" PEX	16	5600007	Pool Heat Exchanger, 316L, 300k Btu	6
2900564	Connector, Compression, 1/2" PEX-AL-PEX	16	5600008	Pool Heat Exchanger, 316L, 360k Btu	6
2900578	Hot Water Sediment Trapper Filter, 3/4" FPT	42	5600009	Pool Heat Exchanger, 316L, 600k Btu	6
2900596	Temperature Gauge, Manifold	16	5600010	Pool Heat Exchanger, 316L, 1200k Btu	6
2900597	6" Chimney Cap, Spark Arrestor	45	5600011	Pool Heat Exchanger, Titanium, 55k Btu	7
2900597	6" Chimney Cap/Spark Arrestor	32	5600012	Pool Heat Exchanger, Titanium, 155k Btu	7
2900598	8" Chimney Cap, Spark Arrestor	45	5600013	Pool Heat Exchanger, Titanium, 300k Btu	7
2900598	8" Chimney Cap/Spark Arrestor	32	5600014	Pool Heat Exchanger, Titanium, 360k Btu	7
2900610	Replacement Fan, motor and shield,	1	5600015	Pool Heat Exchanger, Titanium, 600k Btu	7
2900611	Replacement Fan, motor and shield,	1	5600018	Water-to-Water Heat Exchanger, 33"	6
2900612	Replacement Fan, motor and shield,	2	5600019	Plate Exchanger, 10 x 20-55, 1-1/4" Port	5
2900614	Adapter, Manifold, Female 1" NPT	16	5600021	Panel Radiator, 32" x 16"	8

5600022	Panel Radiator, 36" x 24"	8
5600023	Panel Radiator, 48" x 24"	8
5600029	Heat Exchanger Coil, 100k Btu, 1" Sweat	3
5700034	ThermoPEX, 1", 200' Roll	9
5700043	ThermoPEX, 25mm, 60' Roll	9
5700045	ThermoPEX, 25mm, 500' Roll	9
5700046	ThermoPEX, 25mm, 95' Roll	9
5700047	ThermoPEX, 25mm, 55' Roll	9
5700082	Central PEX 1" Pipe, 8' straight section, 10 per bag	12
5700083	Central PEX 1" Pipe, 8' straight section, 25 per bag	12
5800004	Taco 007 Circulating Pump	13
5800006	Taco 009 Pump	13
5800007	Replacement Cartridge, 009 Series Pumps	14
5800008	Taco 014 Pump	13
5800010	Replacement Cartridge, Bronze, 011 Series Pumps	14
5800011	Taco 007 Priority Pump	13
5800012	Burner Auger Motor	51
5800019	Pump Flange Kit, 1-1/4"	15
5800020	2-Way Zone Sentry Zone Valve, 3/4" NPT threads	30
5800021	3-Way Zone Sentry Zone Valve, 3/4" NPT threads	30
5800022	Replacement Actuator Head for 5800020 and 5800021	30
5800023	Taco Viridian Pump, VR1816F	14
5800025	Taco Viridian Pump, VT2218	14
5800027	2-Way Zone Sentry Zone Valve, 1" sweat	30
5800028	3-Way Zone Sentry Zone Valve, 1" sweat	30
5800030	3-Way Zone Sentry Zone Valve, 3/4" sweat	30
5800033	Pump, Taco 0015e3	14
5800034	O-Ring, Cartridge, Taco 007/009 (set of 2)	15
6000006	Door Seal Only - CleanFire 500	44
6000012	Inspection Window Gasket	52
6000026	Burn Chamber Gasket Only, M255 PE models.	52
6000031	Door Seal Only - CleanFire 300	44
6000032	Door Seal Only - CleanFire 700	44
6000033	Rope Ring (only), 2" Low Density Braid, 8" I.D.	46
6000034	Rope Ring (only), 1.75" Low Density Braid, 6" I.D.	46
6500004	6" Chimney Extension, 4'	33, 45
6500004	6" x 48" Chimney Extension	50
6500011	6" Chimney Snaplock Clamp	50
6500011	Chimney Snaplock Clamp, 6"	45
8200000	Snap Disc, 180-205°F, (High Limit Water Jacket)	43
8200044	Switch - Bypass Alarm.	43
8200275	Power Supply, Stepper Motor.	44
8200277	Electrical Connector, 2-Lever	51
8200278	Electrical Connector, 3-Lever	51
8200279	Electrical Connector, 5-Lever	51
8200293	Power Relay, 24V, SPNO-SPNC	29

NOTES

NOTES

NOTES



Parts for all.

WoodMaster dealers carry complete lines of quality, affordable parts and accessories for most furnace brands, including new and existing heating systems, plus parts and accessories for HeatLink in-floor heat and complementary home comfort systems.

Our selection of hundreds of parts and accessories includes:



HEATLINK MANIFOLD



ASH GRATE SYSTEM



TACO PUMPS



ETC PANEL



WATER TO AIR HEAT EXCHANGER



THERMOPEX

Find your nearest dealer at WoodMaster.com

Your local WoodMaster dealer is: